

ALLOMATIC

AUTOMATIC
TRANSMISSION FILTER CATALOG

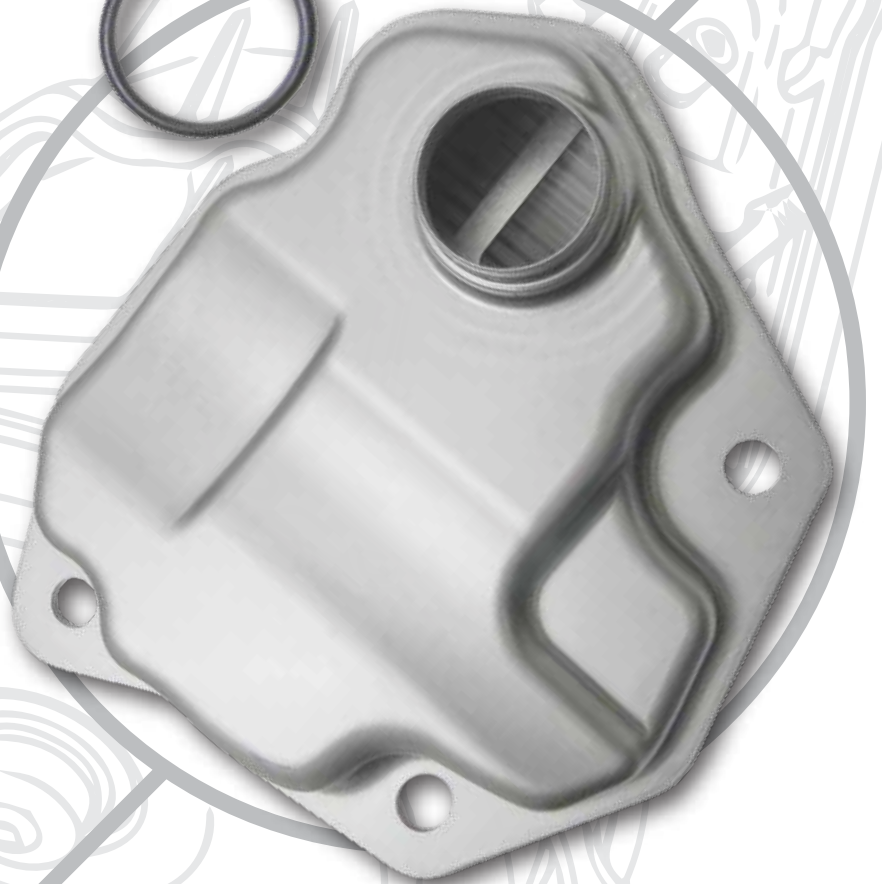

OE QUALITY TRANSMISSION FILTERS

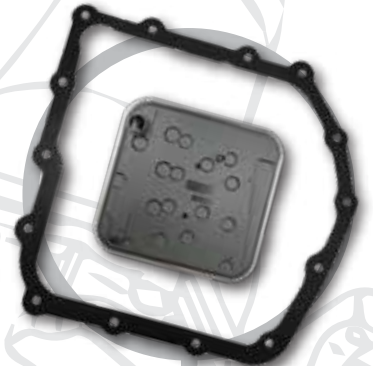

**KEEP IT
CLEAN
WITH OE
QUALITY**

Allomatic transmission filters meet or exceed OEM requirements and provide consistent, reliable protection for every rebuild. Available for both domestic and import applications, our never-leak filters use high-strength, heat-resistant plastic plus premium filter media for maximum protection from debris. Allomatic's goal is to provide maximum value to customers. To do that, our products must meet the challenge of tough OE quality testing. Parts are considered acceptable for shipment only when they have successfully passed stringent quality tests required throughout the manufacturing process. Allomatic quality means service beyond on-time delivery to include timely and consistent sales service, full customer support and responsive new product introduction. Visit Allomatic.com/where-to-buy to find a distributor near you.

Customer Service: 1.800.686.4729

TABLE OF CONTENTS

2	AISIN WARNER
4	ALLISON
6	BORG WARNER
7	CHRYSLER
12	FORD
24	GM
37	HONDA
44	HYUNDAI
45	ISUZU
45	JATCO
45	MAZDA
48	MERCEDES
50	MITSUBISHI
53	NISSAN
59	RENAULT
60	SUBARU
62	SUZUKI
62	TOYOTA
70	VOLKSWAGEN
73	ZF
79	IN-LINE FILTERS
79	PANS
80	MAGNET / FUNNEL
81	TABLE LISTING



AISIN WARNER AW30-40 (Jeep)

1992-2001

Filter: 515310

Gasket: Cork: 03G310, Nitrile: 22G310

Kit: 7310

Pan Bolts: 19

OE: 5083122AA, 83504032, 83504032AB, MR195988



AISIN WARNER AW30-40 (Toyota Supra, SC300/400, LS400, Volvo)

1992-0N

Filter: 515828

Gasket: Cork: 03G310, Nitrile: 22G310

Kit: 7828

Pan Bolts: 19

OE: 35330-50010, 354192008, 3549200-8, 35492008

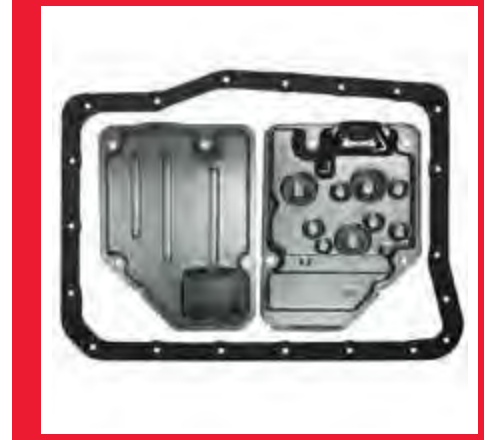

AISIN WARNER AW450-43LE, ISUZU RNJ

1998-0N

Filter: 515889

Gasket: Cork: 03G830, Nitrile: 22G830

Kit: 7889

Pan Bolts: 20

OE: 8-97202067-0, 97202067



AISIN WARNER AW50-40LE

1989-1998

Filter: 515990

Gasket: NA

Kit: No Kit, Disassembly

Pan Bolts: NA

OE: 8651909, 90348726

European



AISIN WARNER AW50-40LM, AW50-41LE, AW50-42LE

1999-2007

Filter: 515888

Gasket: NA

Kit: No Kit, Disassembly

Pan Bolts: NA

OE: 30681088, 5164553, 90541934, 9480049-0



AISIN WARNER AW60-40, AW60-40SN, AW60-41SN, AW60-42LE (AF-13)

1995-2004

Filter: 515890

Gasket: Nitrile: 22G890

Kit: 7890

Pan Bolts: 15

OE: 26445-60G10



AISIN WARNER AW81-40LE (U441E)

2004-ON

Filter: 515540

Gasket: Nitrile: 22G540

Kit: 7540

Pan Bolts: 18

OE: 35330-52010, 93741509



AISIN WARNER GA6F21WA (Mini Cooper)

2007-ON

Filter: 515997

Gasket: NA

Kit: 7997

Pan Bolts: 8

OE: 24-34-7-566-358

With 18mm Pickup Tube



AISIN WARNER GA6F21WA (Mini Cooper)

2005-ON

Filter: 515998

Gasket: NA

Kit: 7998

Pan Bolts: 8

OE: 24-34-7-551-087

With 24mm Pickup Tube



AISIN WARNER TF80SC (AF40, AF40-6), TF81SC (AF21, AWF21), AW6AEL

2005-ON

Filter: 515200

Gasket: NA

Kit: No Kit, Disassembly

Pan Bolts: NA

OE: 60-27-0F099-0080



AISIN WARNER / NISSAN AW55-50SN, AW55-51SN, AF23, AF33, RE5F22A (Nissan, Infiniti)

2003-2007

Filter: 515886

Gasket: NA

Kit: No Kit, Disassembly

Pan Bolts: NA

OE: 31728-8Y000, 31728-8Y010

With Rib



AISIN WARNER / NISSAN AW55-50SN, AW55-51SN, AF23, AF33, RE5F22A (Saab, Saturn, Volvo, Opel)

1999-2007

Filter: 515887

Gasket: NA

Kit: No Kit, Disassembly

Pan Bolts: NA

OE: 24220578, 93177682



AISIN WARNER / NISSAN AW55-50SN, AW55-51SN, AF33-5 (Chevy, Pontiac)

1999-2007

Filter: 515713

Gasket: NA

Kit: No Kit, Disassembly

Pan Bolts: NA

OE: 24240239



AISIN WARNER / TOYOTA TL80SN, AA80E

2007-ON

Filter: 515792

Gasket: NA

Kit: No Kit

Pan Bolts: 9

OE: 35330-50030



ALLISON AT540, AT543, AT545 1970-ON

Filter: 515532

Gasket: Cork: 03G532, Nitrile: 22G532

Kit: 7532

Pan Bolts: 21

OE: 12337210, 29506392D, 29540976, 6438326, 6884270

Stainless Screen



ALLISON AT540, AT543, AT545 1970-ON

Filter: 515732

Gasket: Cork: 03G532, Nitrile: 22G532

Kit: 7732

Pan Bolts: 21

OE: 1878301862, 29503617, 29506392, 94058636

Brass Screen



ALLISON HD SERIES HD4560, B500, MD SERIES 500/P/R/PR

1995-ON

Filter: 515106

Gasket: w/O-ring Kit: SK106

Kit: 7106

Pan Bolts: NA

OE: 29526899, 29540493, 29545776

4? High Canister Style For 2? Sump



ALLISON HD SERIES HD4560, B500, MD SERIES 500/P/R/PR

1995-ON

Filter: 515107

Gasket: w/O-ring Kit: SK106

Kit: 7107

Pan Bolts: NA

OE: 29540494, 29545779, 29545780

6? High Canister Style For 4? Sump



ALLISON HT740, HT747, HT750, HT754, V730

1972-ON

Filter: 515102

Gasket: Cork: 03G105, Nitrile: 22G105

Kit: 7102

Pan Bolts: 23

OE: 6839945

With 6" Tube



ALLISON HT740, HT747, HT750, HT754, V730

1972-1975

Filter: 515103

Gasket: Cork: 03G105, Nitrile: 22G105

Kit: 7103

Pan Bolts: 23

OE: 23045042, 29530562 (KIT)

With 4.5" Tube



ALLISON HT740, HT747, HT750, HT754, V730

1975-ON

Filter: 515104

Gasket: Cork: 03G532, Nitrile: 22G532

Kit: 7104

Pan Bolts: 21

OE: 29538491

With 5" Tube, 7" Pan



ALLISON HT740, HT747, HT750, HT754, V730

1972-ON

Filter: 515105

Gasket: Cork: 03G105, Nitrile: 22G105

Kit: 7105

Pan Bolts: 23

OE: 23013625, 29505563

With 7" Tube



ALLISON LT1000, LT2000, LT2400 SERIES

1999-ON

Filter: 515108

Gasket: NA

Kit: 7108

Pan Bolts: NA

OE: 29531007, 29537268, 29537269, 29539579, 97730071

External Spin On



ALLISON LT1000, LT2000, LT2400 SERIES

1999-2009

Filter: 515482

Gasket: Reusable w/metal torque limiters: 14G482, Nitrile: 22G482

Kit: 7482

Pan Bolts: 12

OE: 29537514, 29537965

Shallow Pan



**ALLISON LT1000, LT2000,
LT2400 SERIES**

1999-2009

Filter: 515483

Gasket: Reusable w/metal torque limiters:

14G482, Nitrile: 22G482

Kit: 7483

Pan Bolts: 12

OE: 29537617, 29537966

Deep Pan



**ALLISON LT1000, LT2000,
LT2400 SERIES**

2010-ON

Filter: 515484

Gasket: Reusable w/metal torque limiters:

14G482, Nitrile: 22G482

Kit: 7484

Pan Bolts: 12

OE: 29542833

Shallow Pan



**ALLISON LT1000, LT2000,
LT2400 SERIES**

2010-ON

Filter: 515485

Gasket: Reusable w/metal torque limiters:

14G482, Nitrile: 22G482

Kit: 7485

Pan Bolts: 12

OE: 29542824

Sump Filter (Deep Pan)



**ALLISON MT640, MT643, MT644,
MT650, MT653, MT654**

1972-ON

Filter: 515101

Gasket: Cork: 03G532, Nitrile: 22G532

Kit: 7101

Pan Bolts: 21

OE: 23012457, 23019201, 29502302,
29527373, 29538474, 29538489,
29538490, 29538492, 5574991,
6882787, 6883044, 6885287

Late Without Tube



**BORG WARNER T35, T37, T44,
T65, T66**

1963-ON

Filter: 515500

Gasket: Nitrile: 22G504

Kit: 7500

Pan Bolts: 15

OE: 3170356, 3179973, DORY-7A098-A
Front Shroud - 199 Engine 1968-70



**BORG WARNER T35, T37, T44,
T65, T66**

1969-ON

Filter: 515501

Gasket: Nitrile: 22G504

Kit: 7501

Pan Bolts: 15

OE: 3188896, AAU7085, MD950886
Front Shroud Except 199 Engine 1968-70



BORG WARNER T35, T37, T44, T65, T66

1962-ON

Filter: 515504

Gasket: Nitrile: 22G504

Kit: 7504

Pan Bolts: 15

OE: 3164950, 3170356, 3179973

AMC Flashomatic



BORG WARNER T35, T37, T44, T65, T66

1981-1993

Filter: 515502

Gasket: Nitrile: 22G504

Kit: No Kit

Pan Bolts: 12

OE: 4277455, DORY-7A098-B

Filter - Transmission Filter (Saab 4 Speed)



BORG WARNER / BTR BW-85, 85, 91, 95LE, 74, 93, 97LE

1989-ON

Filter: 515505

Gasket: NA

Kit: No Kit

Pan Bolts: NA

OE: ED78000KTF, TGM-10011

Sump Filter (Pan)



CHRYSLER 42RE, 44RE, 46RE, 47RE, 48RE

1997-2004

Filter: 515607

Gasket: Cork: 03G413, 03G613, 63G613

Nitrile: 22G413, 22G613

Kit: 7607

Pan Bolts: 14, 14

OE: 52118789



CHRYSLER 42RLE

2003-ON

Filter: 515608

Gasket: Cork: 03G608, Nitrile: 22G608

Kit: 7608

Pan Bolts: 14

OE: 52852913AA, 52852913AB

4 Speed



CHRYSLER 45RFE, 545RFE

1999-ON

Filter: 514129

Gasket: NA

Kit: No Kit

Pan Bolts: NA

OE: 4799086

Bleed Orifice Filter



CHRYSLER 45RFE, 545RFE (2WD), 68RFE (2WD)(07-ON)

1999-2009

Filter: 515494

Gasket: Cork: 03G492, Nitrile: 22G492

Kit: 7494

Pan Bolts: 15

OE: 04800029AA, 05015267AC

Sump Filter With Lipseal And Valve



CHRYSLER 45RFE, 545RFE, 65RFE, 66RFE (2WD), 68RFE (4WD)

(2WD) 10-ON (4WD) 99-ON, 66RFE (2WD) 12-ON, 68RFE (4WD) 07-ON

Filter: 515492

Gasket: Cork: 03G492, Nitrile: 22G492

Kit: 7492

Pan Bolts: 15

OE: 05013470AA, 05013470AB, 05013470AC, 05013470AD, 05013470AE, 4799507

Sump Filter With Lipseal And Valve, 545RFE



CHRYSLER 45RFE, 545RFE, 65RFE, 66RFE, 68RFE (2WD, 4WD)

1999-ON

Filter: 515490

Gasket: Cork: 03G492, Nitrile: 22G492

Kit: 7490

Pan Bolts: NA

OE: 04799662AB, 05179267AC, 4799662, 4799662A, 4799662AB, 5179267AC

Spin On



CHRYSLER 62TE

2007-ON

Filter: 515610

Gasket: Nitrile: 22G610

Kit: 7610

Pan Bolts: 12

OE: 68018555AA



CHRYSLER 6F24

2012-ON

Filter: 515624

Gasket: NA

Kit: No Kit, Disassembly

Pan Bolts: NA

OE: 68192984AA

With Green Rectangle Seal



CHRYSLER 722.6 (96-ON), NAG1 (W5A380) (04-ON)

1996-ON

Filter: 515870

Gasket: 04G870

Kit: 7870

Pan Bolts: 6

OE: 140-272-0095, 140-277-0095, 52108325AA, BU01-19-815, JLM20470



**CHRYSLER 845RE
2013-ON**

Filter: 515769
 Gasket: Comes with filter
 Kit: No Kit
 Pan Bolts: 13
 OE: 52854834AA
 Deep Pan With Replaceable Filter Includes Pan
 Gasket, Drain Plug And Magnets



**CHRYSLER A404, 30TH, 31TH,
A413, A470, A670
1978-ON**

Filter: 514113
 Gasket: NA
 Kit: No Kit
 Pan Bolts: NA
 OE: 5205839
 Governor Filter



**CHRYSLER A404, 30TH, 31TH,
A413, A470, A670 (Early)
1978-1982**

Filter: 515411
 Gasket: Cork: 03G411, Nitrile: 22G411
 Kit: 7411
 Pan Bolts: 14
 OE: 4207219, 5212145



**CHRYSLER A404, 30TH, 31TH,
A413, A470, A670 (Late)
1983-ON**

Filter: 515470
 Gasket: Cork: 03G411, Nitrile: 22G411
 Kit: 7470
 Pan Bolts: 14
 OE: 4269649, 4289249



**CHRYSLER A500 / 44RE, A500 / 40RH,
42RH, 44RH, A500SE / 42RE, A904 /
A500, A518 / 46RH, A518ES / 46RE,
A618 / 47RH, A618ES / 47RE, 48RE,
TF6, A904 / 30RH, A998 / 31RH, A999 /
32RH, TF8, A727 / 36RH / 37RH
1967-2003**

Filter: 515613
 Gasket: Cork: 03G613, 03G712, Nitrile: 22G613
 Kit: 7612, 7613, 7614
 Pan Bolts: 14
 OE: 3515996, 8123042, J8123042, M3515996
 All Large, Felt 1 Hole



**CHRYSLER A604 (4 Speed)
1989-ON**

Filter: 515604
 Gasket: Cork: 03G604, 63G604, Nitrile: 22G604
 Kit: 7604
 Pan Bolts: 14
 OE: 04864505AB, 4504048, 4864505, M04504048, M04864505, M04504048



CHRYSLER A604, 40TE, 41TE, 41AE

1989-ON

Filter: 514105

Gasket: NA

Kit: No Kit

Pan Bolts: NA

OE: 4446629

Orifice Filter



CHRYSLER A604, 40TE, 41TE, 41AE

1989-ON

Filter: 514107

Gasket: NA

Kit: No Kit

Pan Bolts: NA

OE: 4531903

Orifice Filter



CHRYSLER A604, 40TE, 41TE, 41AE

1999-ON

Filter: 514130

Gasket: NA

Kit: No Kit

Pan Bolts: NA

OE: 50008024AA

Solenoid Block



CHRYSLER A604, 40TE, 41TE, 41AE, 42RL

1989-ON

Filter: 514103

Gasket: NA

Kit: No Kit

Pan Bolts: NA

OE: 3738313, 3878313

Pump, Valve Body Filter



CHRYSLER A606, 42LE

1993-ON

Filter: 514109

Gasket: NA

Kit: No Kit

Pan Bolts: NA

OE: 4539787

A606, 42LE Spacer Plate



CHRYSLER A606, 42LE (4 Speed)

1993-ON

Filter: 515606

Gasket: Cork: 03G606, Nitrile: 22G606

Kit: 7606

Pan Bolts: 13

OE: 4626449, 4796730, 4796730AB



CHRYSLER AS68RC

2007-ON

Filter: 515617

Gasket: Nitrile: 22G617

Kit: 7617

Pan Bolts: 18

OE: 68019688AA

Sump Filter



CHRYSLER / ISUZU AS68RC (2WD)

2007-ON

Filter: 515618

Gasket: Nitrile: 22G617

Kit: 7618

Pan Bolts: 18

OE: 8-98079401-0

Sump Filter (2WD Shallow Pan) (Isuzu)



CHRYSLER AS69RC

2013-ON

Filter: 515619

Gasket: Nitrile: 22G619

Kit: 7619

Pan Bolts: 20

OE: 68224232AA

(6 Speed)



CHRYSLER TF6, A904 / 30RH, A998 / 31RH, A999 / 32RH, TF8, A727 / 36RH / 37RH

1960-2003

Filter: 514127

Gasket: NA

Kit: No Kit

Pan Bolts: NA

OE: 3743519

TF6 Governor Filter

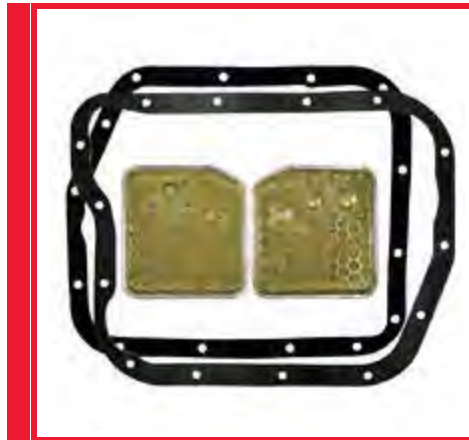

CHRYSLER TF6, A904 / 30RH, A998 / 31RH, A999 / 32RH, TF8, A727 / 36RH / 37RH

1966-2003

Filter: 515714

Gasket: Cork: 03G613, 03G712, Nitrile:

22G613, 22G712

Kit: 7714

Pan Bolts: 14, 14

OE: 3515996, 8123042

All Large, Brass, 1 Hole



CHRYSLER TF6, TF8, A727 / 36RH / 37RH

1960-1967

Filter: 515413

Gasket: Cork: 03G413, Nitrile: 22G413

Kit: 7412

Pan Bolts: 14

OE: 3621456, 8121065, 8122610

Small, Felt, 2 Holes



CHRYSLER TF6, TF8, A727 / 36RH / 37RH

1960-1967

Filter: 515514

Gasket: Cork: 03G413, Nitrile: 22G413, Nitrile22G613

Kit: 7514

Pan Bolts: 14, 14

OE: 3410253

Small, Brass, 2 Holes



FORD 5R110W TorqShift

2008-ON

Filter: 515196

Gasket: Cork: 03G042, Nitrile: 22G042

Kit: 7196

Pan Bolts: 20

OE: 8C3Z-7A098-D

Internal Sump Filter



FORD 5R110W TorqShift

2008

Filter: 515197

Gasket: NA

Kit: No Kit

Pan Bolts: NA

OE: 7C3Z-7B155-B

External Remote Mount Cooler Line Filter



FORD 5R110W TorqShift

2003-2007

Filter: 515574

Gasket: NA

Kit: No Kit

Pan Bolts: NA

OE: 3C3Z-7B155-BA

External bypass, Element

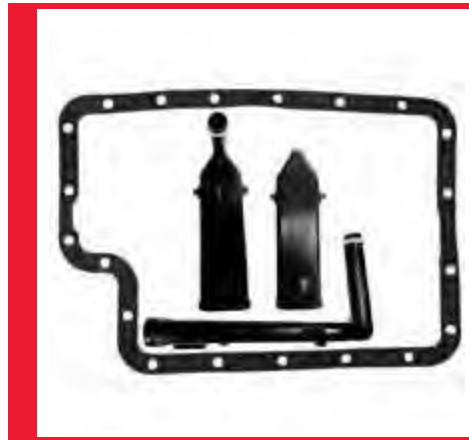

FORD 5R110W TorqShift

2003-ON

Filter: 515577

Gasket: Cork: 03G042, Nitrile: 22G042

Kit: 7577

Pan Bolts: 20

OE: 3C3Z-7A098-AA

Internal



FORD 5R55N, 5R55S

2003-2005

Filter: 515575

Gasket: Cork: 03G576, 63G576, Nitrile: 22G576

Kit: 7575

Pan Bolts: 16

OE: 3W4Z-7A098-AA

Short Tube



FORD 5R55N, 5R55S (Car Only)

1999-2002

Filter: 515578

Gasket: Cork: 03G578, Reusable w/metal torque limiters: 14G578, Nitrile: 22G578

Kit: 7578

Pan Bolts: 16

OE: XR85498, XW4Z-7A098-BA, XW4Z-7A098-BB

All Plastic, Short Tube



FORD 5R55W

2002-ON

Filter: 515576

Gasket: Cork: 03G576, 63G576, Nitrile: 22G576

Kit: 7576

Pan Bolts: 16

OE: 1L2Z-7A098-AC, 1L2Z-7A098-AB

Long Tube



FORD 6F35

2009-2012

Filter: 515265

Gasket: NA

Kit: No Kit, Disassembly

Pan Bolts: NA

OE: 9L8Z-7A098-A, 9L8Z-7A098-B, 9L8Z-7A098-C



FORD 6F35

2012-ON

Filter: 515267

Gasket: NA

Kit: No Kit, Disassembly

Pan Bolts: NA

OE: BB5Z-7A098-B

Inlet Height .562"

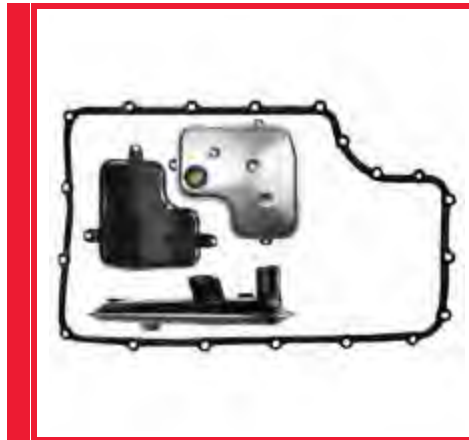

FORD 6R140

2011-ON

Filter: 515198

Gasket: Reusable w/metal torque limiters: 14G198, Nitrile: 22G198

Kit: 7198

Pan Bolts: 19

OE: BC3Z-7A098-B



FORD 6R60, 6R75

2006-2007

Filter: 515264

Gasket: Cork: 03G263, OE-Style Aluminum + Rubber: 14G263, Nitrile: 22G263

Kit: 7264

Pan Bolts: 21

OE: 6L2Z-7A098-AA

With Flat Bottom, 3.003" Neck



FORD 6R60, 6R75, 6R80

2007-2010

Filter: 515263

Gasket: Cork: 03G263, OE-Style Aluminum + Rubber: 14G263, Nitrile: 22G263

Kit: 7263

Pan Bolts: 21

OE: 7L1Z-7A098-A

With 1.5" Pickup Tube



FORD 6R80, 6R100

2011-2018

Filter: 515273

Gasket: Cork: 03G263, OE-Style Aluminum + Rubber: 14G263, Nitrile: 22G263

Kit: 7273

Pan Bolts: 21

OE: BL3Z-7A098-A

Shallow Pan



FORD 6R80 (F150 2.7L, 3.3L, 3.5L)

2015-2018

Filter: 515271

Gasket: Nitrile: 14G263, 22G263

Kit: No Kit

Pan Bolts: 21

OE: FL3Z-7A098-A, FL3Z-7A098-B

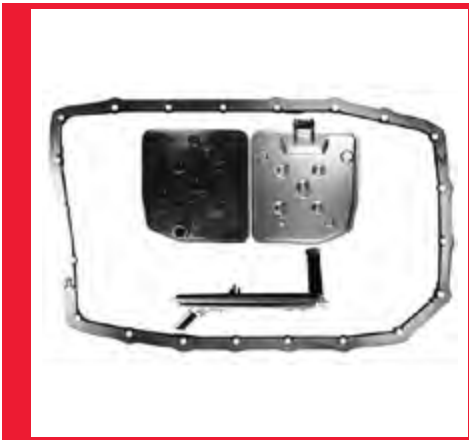

FORD 6R80 (Ford Transit)

2015-ON

Filter: 515272

Gasket: Cork: 03G263, OE-Style Aluminum + Rubber: 14G263, Nitrile: 22G263

Kit: No Kit

Pan Bolts: 21

OE: CK4Z-7A098-A

With Long Metal Inlet



FORD 10R80

2017-ON

Filter: 515280

Gasket: NA

Kit: No Kit

Pan Bolts: 18

OE: HL3Z-7A098-A

Round Inlet

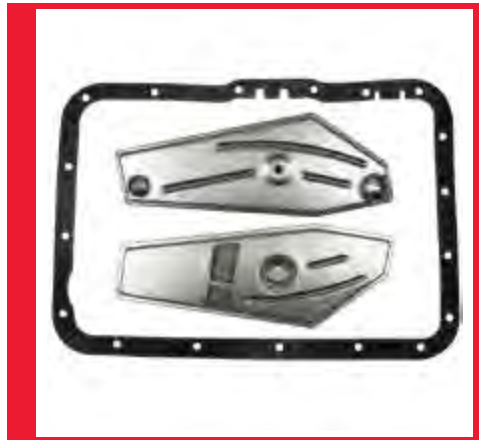

FORD A4LD (2WD)

1985-1988

Filter: 515582

Gasket: Cork 03G582, Nitrile 22G582

Kit: 7582

Pan Bolts: 18

OE: 84GT-7A098-AD, E5TZ-7A098-B, E6TZ-7A098-B



FORD A4LD (2WD)

1989-1996

Filter: 515586

Gasket: Cork: 03G582, Nitrile: 22G582

Kit: 7586

Pan Bolts: 18

OE: E7TZ-7A098-A, E9TZ-7A098-C, ZZL2-21-500



FORD A4LD (4WD)

1985-1996

Filter: 515584

Gasket: Cork: 03G582, Nitrile: 22G582

Kit: 7584

Pan Bolts: 18

OE: 85GT-7A098-AC, E5TZ-7A098-A, E6TZ-7A098-A, XL2Z-7A098-BA, ZZL1-21-500



FORD A4LD-E (4WD), 4R55E, 5R55E (4WD)

1995-ON

Filter: 515580

Gasket: Cork: 03G582, Nitrile: 22G582

Kit: 7580

Pan Bolts: 18

OE: 1F0121296, F5TZ-7A098-B, XL2Z-7A098-AB, XL2Z-7A098-BA, XL2Z-7A098-DA, ZZM1-21-296

09G580 Bolt Can Be Used With 5579 & 5580 S To Retro-fit The A4LD Transmission Back To 1985



FORD A4LD-E, 4R44E (2WD)

1995-ON

Filter: 515579

Gasket: Cork: 03G582, Nitrile: 22G582

Kit: 7579

Pan Bolts: 18

OE: 1F0021296, F5TZ-7A098-A, XL2Z-7A098-AA, XL2Z-7A098-CA, ZZM0-21-296



FORD AOD, FIOD (2WD)

1980-1994

Filter: 515419

Gasket: Cork: 03G419, 63G419, Nitrile: 22G419

Kit: 7419

Pan Bolts: 14

OE: E0AZ-7A098-A, E0AZ-7A098-C, E1AZ-7A098-A



FORD AOD, FIOD (4WD)

1985-1994

Filter: 515258

Gasket: Cork: 03G419, 63G419, Nitrile: 22G419

Kit: 7258

Pan Bolts: 14

OE: E4TP-7F003-AA, E5TZ-7A098-C
Long Pickup Tube



FORD AODE

1992-0N

Filter: 514215

Gasket: NA

Kit: No Kit

Pan Bolts: NA

OE: F2VP-7H187-AA

Force Motor Filter



FORD AODE (2WD)

1992-1996

Filter: 515257

Gasket: Cork: 03G257, Reusable w/metal torque limiters: 14G257, Nitrile: 22G257

Kit: 7257

Pan Bolts: 14

OE: F2VY-7A098-A



FORD AODE (4WD 92-0N), (2WD 96-0N)

1992-0N

Filter: 515256

Gasket: Cork: 03G257, Reusable w/metal torque limiters: 14G257, Nitrile: 22G257

Kit: 7256

Pan Bolts: 14

OE: F4TZ-7A098-A, F6AZ-7A098-A

Long Tube



FORD ATX

1981-1994

Filter: 514205

Gasket: NA

Kit: No Kit

Pan Bolts: NA

OE: E9EP-7E242-AA

Governor Filter



FORD ATX

1981-1994

Filter: 515260

Gasket: Cork: 03G260, Nitrile: 22G260

Kit: 7260

Pan Bolts: 13

OE: E1EP-7B155, E1EP-7B155-BB, E1FZ-7A098-A, E1FZ-7B098-A, E9FZ-7A098-A



FORD AX4N

1998-0N

Filter: 514202

Gasket: NA

Kit: No Kit

Pan Bolts: NA

OE: F8DP-7G186-AA

Valve Body Filter



FORD AX4N (95-ON), AX4S SHO (88-95)

1988-ON

Filter: 515252

Gasket: Cork: 03G259, Reusable w/metal torque limiters: 14G259, Nitrile: 22G259

Kit: 7251

Pan Bolts: 19

OE: F5DZ-7A098-A, F5DZ-7A098-AA, F5DZ-7A098-BA

Orange



FORD AX4S

1986-1996

Filter: 515255

Gasket: Cork: 03G259, 63G259, Reusable w/metal torque limiters: 14G259, Nitrile: 22G259

Kit: 7255

Pan Bolts: 17

OE: E6DZ-7A098-A, F4DZ-7A098-A, F4DZ-7A098-B, F4DZ-7A098EA, F5DZ-7A098-B, F5DZ-7A098-BA

Orange



FORD AX4S SHO

1996-ON

Filter: 515253

Gasket: Cork: 03G259, 63G259, 03G252, Reusable w/metal torque limiters: 14G252, Nitrile: 22G259

Kit: 7253, 7250

Pan Bolts: 19, 17

OE: F6DZ-7A098-A, F6DZ-YA098-AA

Green



FORD AXOD

1986-1990

Filter: 515259

Gasket: Cork: 03G259, 63G259, Reusable w/metal torque limiters: 14G259, Nitrile: 22G259

Kit: 7259

Pan Bolts: 17

OE: E6DZ-7A098-A



FORD AXOD

1986-ON

Filter: 514200

Gasket: NA

Kit: No Kit

Pan Bolts: NA

OE: E9SP-7G308-AA

Pump, Valve Body Filter



FORD AXOD SHO

1988-1993

Filter: 515254

Gasket: Cork: 03G259, 63G259, Reusable w/metal torque limiters: 14G259, Nitrile: 22G259

Kit: 7254

Pan Bolts: 17

OE: F3DZ-7A098-A, F5DZ-7A098A



FORD AXOD-E

1991-ON

Filter: 514201

Gasket: NA

Kit: No Kit

Pan Bolts: NA

OE: E9DZ-7H162-A

Valve Body Filter



FORD C3

1974-1989

Filter: 515301

Gasket: Cork: 03G301, Nitrile: 22G301

Kit: 7301

Pan Bolts: 13

OE: D4ZZ-7A098-A, D4ZZ-7A098-B



FORD C4

1964-1965

Filter: 515543

Gasket: Cork: 03G474, Nitrile: 22G474

Kit: 7543

Pan Bolts: 11

OE: C4AZ-7A098-C, C5AP-7A098-D



FORD C4

1965-1970

Filter: 515544

Gasket: Cork: 03G474, Nitrile: 22G474

Kit: 7544

Pan Bolts: 11

OE: C5AZ-7A098-C



FORD C4 (Bobcat, Mustang, Pinto, Versailles)

1974-1981

Filter: 515274

Gasket: Cork: 03G474, Nitrile: 22G474

Kit: 7274

Pan Bolts: 11

OE: D4FZ-7A098-A, D4FZ-7A098-B

Deep Pan



FORD C4 (Bronco)

1973-1977

Filter: 515590

Gasket: Cork: 03G474, Nitrile: 22G474

Kit: 7590

Pan Bolts: 11

OE: D3BZ-7A098-A, D3BZ-7A098-B, D3TZ-7A098-C



FORD C4 (Except Mustang, Pinto, Bobcat, Bronco, '70 Falcon, Maverick)

1970-1981

Filter: 515474

Gasket: Cork: 03G474, Nitrile: 22G474

Kit: 7474

Pan Bolts: 11

OE: D0DZ-7A098-A, D0DZ-7A098-B, D0DZ-7A098-C



FORD C5 (4WD)(Bronco, Ranger, Light Trucks)

1983-1986

Filter: 515184

Gasket: Cork: 03G474, Nitrile: 22G474

Kit: 7184

Pan Bolts: 11

OE: E3TZ-7A098-A

Deep Pan



FORD C5 (Except Peb. Trans.) 1982-1986

Filter: 515174

Gasket: Cork: 03G474, Nitrile: 22G474

Kit: 7174

Pan Bolts: 11

OE: E2AP=7B003-AA, E2DZ-7A098-A



FORD C6 (All Except Truck, 4WD)

1966-1975

Filter: 515529

Gasket: Cork: 03G529, 63G529, Nitrile: 22G529

Kit: 7529

Pan Bolts: 17

OE: C6AZ-7A098-A, C6AZ-7A098-B, C6VY-7A098-A, C6VY-7A098-B



FORD C6 (All Except Truck, 4WD)

1976-1996

Filter: 515629

Gasket: Cork: 03G529, 63G529, Nitrile: 22G529

Kit: 7629

Pan Bolts: 17

OE: D5AZ-7A098-A, D5AZ-7A098-B, D6AZ-7A098-AA, D6AZ-7A098-BB



FORD C6 (Truck, 4WD)

1976-1996

Filter: 515589

Gasket: Cork: 03G529, 63G529, Nitrile: 22G529

Kit: 7589

Pan Bolts: 17

OE: D3TZ-7A098-A, D3TZ-7A098-B



FORD CFT23, CVT (European Focus, Focus C-Max)

2004-ON

Filter: 515266

Gasket: NA

Kit: No Kit

Pan Bolts: NA

OE: 0501-214-113

Deep Pan



FORD CFT23, CVT (European Focus, Focus C-Max)

2004-ON

Filter: 515587

Gasket: NA

Kit: No Kit

Pan Bolts: NA

OE: 0501-212-996

Shallow Pan



FORD CFT30, CVT 2005-2007

Filter: 515202

Gasket: NA

Kit: No Kit

Pan Bolts: NA

OE: 5F9Z-7B155-AA, 5F9Z-7B155-Y



FORD CFT30, CVT

2005-ON

Filter: 515195

Gasket: Cork: 03G195, Nitrile: 22G195

Kit: 7195

Pan Bolts: 22

OE: 5F9Z-7A098-A, 5F9Z-7A098-B



FORD E40D, 4R100

1989-ON

Filter: 514210

Gasket: NA

Kit: No Kit

Pan Bolts: NA

OE: F1TP-7H194-AA

4X4 Accumulator Filter



FORD E40D, 4R100

1989-ON

Filter: 514211

Gasket: NA

Kit: No Kit

Pan Bolts: NA

OE: E9TP-7G308-CA

Shift Filter



FORD E40D, 4R100 (2WD)

1988-2005

Filter: 515042

Gasket: Cork: 03G042, Reusable w/metal torque limiters: 14G042, Nitrile: 22G042

Kit: 7042

Pan Bolts: 20

OE: E9TZ-7A098-A, F6TZ-7A098-AB, YC3Z-7A098-AA

Shallow Pan



FORD E40D, 4R100 (4WD)

1988-2005

Filter: 515044

Gasket: Cork: 03G042, Reusable w/metal torque limiters: 14G042, Nitrile: 22G042

Kit: 7044

Pan Bolts: 20

OE: E9TZ-7A098-B, F6TZ-7A098-BB, YC3Z-7A098-BA

Deep Pan



FORD FMX

1978-1981

Filter: 515530

Gasket: Cork: 03G530, Nitrile: 22G530

Kit: 7530

Pan Bolts: 14

OE: D8AZ-7A098-A, D8AZ-7A098-B

Iron Case, Felt



FORD FMX

1968-1977

Filter: 515531

Gasket: Cork: 03G530, Nitrile: 22G530

Kit: 7531

Pan Bolts: 14

OE: 14082735, D0AZ-7A098-A

Iron Case, Brass



FORD FX, FM

1951-1967

Filter: 515429

Gasket: 22G530

Kit: 7429

Pan Bolts: 14

OE: B9AP-7A098-A

Small, Iron Case



FORD HF35 / EVT

2013-2015

Filter: 515270

Gasket: NA

Kit: No Kit

Pan Bolts: NA

OE: DG9Z-7A098-A



FORD MX (Except Lincoln)

1960-1967

Filter: 515431

Gasket: Nitrile: 22G431

Kit: 7431

Pan Bolts: 15

OE: B9MP-7A098-B

Medium, Iron Case



FORD (European Models) CTX

1987-1989

Filter: 515527

Gasket: NA

Kit: No Kit, Disassembly

Pan Bolts: NA

OE: 87CT-7B155-AA, 87CT-7B155-AB

Filter - CVT (2.5" Tube)



FORD (European Models) CVT, NCVT, CTX

1989-2001

Filter: 515194

Gasket: NA

Kit: No Kit

Pan Bolts: 13

OE: 6184137, 87CT-7B155-AB

.75" Tube



FORD / GM 6F50, 6F55, 6T70, 6T75

2007-ON

Filter: 515192

Gasket: NA

Kit: No Kit, Disassembly

Pan Bolts: NA

OE: 24223670, 24240104, 7T4Z-7A098-B



FORD / MAZDA 4EAT-G, G4AEL, G4AHL, N4A

1986-1987

Filter: 515847

Gasket: Cork: 03G847, Nitrile: 22G847

Kit: 7847

Pan Bolts: 17

OE: FU01-21-500C, FU01-21-500E, FU01-21-500F

.625" Thick

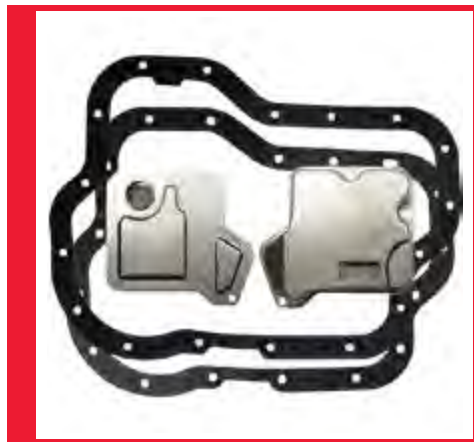

FORD / MAZDA 4EAT-G, G4AEL, G4AHL, N4A

1987-1992

Filter: 515848

Gasket: Cork: 03G847, 03G848, Nitrile: 22G847, 22G848

Kit: 7848

Pan Bolts: 17

OE: E92Z-7A098-A, E92Z-7A098-AA, FU31-21-500, FU3A-21-500

1" Thick



FORD / MAZDA 4EAT-G, G4AEL, G4AHL, N4A

1988-1994

Filter: 515849

Gasket: 22G847

Kit: 7849

Pan Bolts: 17

OE: FOJY-7A098-A, FU50-21-500A

1.25" Thick



FORD / MAZDA 4F27E, J39A, FN4A-EL

1999-ON

Filter: 515873

Gasket: Cork: 03G873, 63G873, Nitrile: 22G873

Kit: 7873

Pan Bolts: 20

OE: FN01-21-500, XS4Z-7A098-AB, XS4Z-7A098-AC



FORD / MAZDA 4F27E, J39A, FN4A-EL (99-ON), FNR5, FS5A-EL (05-ON)

1999-ON

Filter: 515262

Gasket: Cork: 03G873, 63G873, Nitrile: 22G873

Kit: 7262

Pan Bolts: 20

OE: 6E5Z-7B155-A, 8E5Z-7B155-A, FNC1-21-500

Deep Pan, Sump Filter



FORD / MAZDA CD4E, LA4AEL

1994-ON

Filter: 515261

Gasket: Cork: 03G261, Nitrile: 22G261

Kit: 7261

Pan Bolts: 14

OE: F3RP-7A098-A, F3RZ-7A098-A, F3RZ-7A098-AA, FW50-21-500 CD4E



FORD / MAZDA EAT, 4EAT-F, F4E, F4E-III, F4AEL

1990-ON

Filter: 515943

Gasket: Cork: 03G843, Nitrile: 22G843

Kit: 7943

Pan Bolts: 19

OE: FW01-21-500, KFW01-21-500 4EAT-F, F4A-EL



FORD / MAZDA EAT, 4EAT-F, F4E, F4E-III, F4AEL

1990-ON

Filter: 515944

Gasket: Cork: 03G843, Nitrile: 22G843

Kit: 7944

Pan Bolts: 19

OE: FU61-21-500B F4EL, 4EATF



FORD / MAZDA EAT, 4EAT-F, F4E, F4E-III, F4AEL (Escort, Tracer, 323, Protege, Kia Sephia)

1991-ON

Filter: 515843

Gasket: Cork: 03G843, Nitrile: 22G843

Kit: 7843

Pan Bolts: 19

OE: F1CZ-7A098-A, F1CZ-7A098-AA, FU61-21-500B, KF06-12-1500, MFU6121500B



FORD / MAZDA G4AEL

1993-ON

Filter: 515871

Gasket: Cork: 03G847, Nitrile: 22G847

Kit: 7871

Pan Bolts: 17

OE: F32Z-7A098-A, F32Z-7A098-AA, FU9A-21-500



FORD GETRAG MPS6

2009-ON

Filter: 515204

Gasket: NA

Kit: No Kit

Pan Bolts: NA

OE: 7M5R-6C631-AD



FORD GETRAG MPS6

2008-ON

Filter: 515588

Gasket: NA

Kit: No Kit, Disassembly

Pan Bolts: NA

OE: 7M5R-7G186-AB



FORD GETRAG SPS6

2009-ON

Filter: 515350

Gasket: NA

Kit: No Kit

Pan Bolts: NA

OE: 2-1016-010, 7U3R-7G186-AB



GM 2ML70 2-MODE HYBRID

2007-2013

Filter: 515702

Gasket: NA

Kit: No Kit

Pan Bolts: 13

OE: 1916-8277



GM 3L30, TH180, TH180C (3 Speed)

1969-ON

Filter: 515817

Gasket: Cork: 03G817, Nitrile: 22G817

Kit: 7817

Pan Bolts: 12

OE: 14024456, 25010641, 26950-61A00, 5258130, 747451, 96040620, 9921689



GM 3T40, TH125, TH125C

1980-ON

Filter: 515128

Gasket: Cork: 03G128, 63G128, Nitrile: 22G128

Kit: 7128

Pan Bolts: 16

OE: 25010991, 8665904
With Lipseal (Replaces 515127)



GM 4L30E (4 Speed BMW)

1990-ON

Filter: 515836

Gasket: Cork: 03G836, Nitrile: 22G836

Kit: 7836

Pan Bolts: 16

OE: 24111-218-899, 96015432



GM 4L30E (4 Speed ISUZU)

1990-ON

Filter: 515180

Gasket: Cork: 03G180, Nitrile: 22G180

Kit: 7180

Pan Bolts: 16

OE: 8-96015062-0, 8-96041011-0



GM 4L60E

2005-2007

Filter: 515697

Gasket: NA

Kit: No Kit

Pan Bolts: NA

OE: 5-9005-000
Auxiliary Pump Filter



GM 4L60E

1993-ON

Filter: 515703

Gasket: Cork: 03G700, 63G700, Nitrile: 22G700

Kit: 7703

Pan Bolts: 16

OE: 24200796, 24208148, 24208835, 24229186, 24236798, 24236799
Shallow Pan



GM 4L60E

1998-ON

Filter: 515704

Gasket: Cork: 03G700, 63G700, Nitrile: 22G700

Kit: 7704

Pan Bolts: 16

OE: 2420-8576, 24208465, 24208576, 24208813, 8-24208576-6, 8-24208813-3
Deep Pan



GM 4L60E

1993-ON

Filter: 514348

Gasket: NA

Kit: No Kit

Pan Bolts: NA

OE: 8683769

Shift Filter



GM 4L60E

1993-ON

Filter: 514383

Gasket: NA

Kit: No Kit

Pan Bolts: NA

OE: 8683768

Force Motor Filter (74 Micron)



GM 4L60E

1993-ON

Filter: 515701

Gasket: Cork: 03G700, 63G700, Nitrile: 22G700

Kit: 7701

Pan Bolts: 16

OE: 24200796, 25325574, 8-24200796-6, 8681082, 8685774, 8685950, 96040313



GM 4L60E (Canyon, Colorado, H3, Sierra, Isuzu)

2005-ON

Filter: 515707

Gasket: Cork: 03G700, 63G700, Nitrile: 22G700

Kit: 7707

Pan Bolts: 16

OE: 24225323, 8-24225323-0, 8-24225323-3

Shallow Pan Step Filter



GM 4L60E (Corvette)

1997-2007

Filter: 515705

Gasket: Cork: 03G700, 63G700, Nitrile: 22G700

Kit: 7705

Pan Bolts: 16

OE: 24208149, 24208574, 24208836

**GM 4L80E****1991-ON**

Filter: 514385

Gasket: NA

Kit: No Kit

Pan Bolts: NA

OE: 8685041

Force Motor Filter

**GM 4L80E****1991-1996**

Filter: 515480

Gasket: Cork: 03G480, Reusable w/metal torque limiters: 14G480, Nitrile: 22G480

Kit: 7480

Pan Bolts: 17

OE: 8675545, 8678757, 8684221, JLM10952

Shallow Pan

**GM 4L80E****1991-ON**

Filter: 514380

Gasket: NA

Kit: No Kit

Pan Bolts: NA

OE: 8661709

Shift Filter

**GM 4L80E****1991-ON**

Filter: 514381

Gasket: NA

Kit: No Kit

Pan Bolts: NA

OE: 8661834

PWM Filter

**GM 4L80E, THMR2****1997-ON**

Filter: 515481

Gasket: Cork: 03G480, Reusable w/metal torque limiters: 14G480, Nitrile: 22G480

Kit: 7481

Pan Bolts: 17

OE: 24204277, 24208847, 24210468, 24210956

Deep Pan

**GM 4T40E****1995-ON**

Filter: 515129

Gasket: Cork: 03G129, Reusable w/metal torque limiters: 14G129, Nitrile: 22G129

Kit: 7129

Pan Bolts: 12

OE: 24203370, 24221762, 8685185



GM 4T60, TH440

1983-1993

Filter: 514339

Gasket: NA

Kit: No Kit

Pan Bolts: NA

OE: 24208456, 8644494

Pump, Valve Body Filter (Old 4342)



GM 4T60, TH440

1983-1993

Filter: 514341

Gasket: NA

Kit: No Kit

Pan Bolts: NA

OE: 8649474

Shift Filter



GM 4T60, TH440

1983-1993

Filter: 514343

Gasket: NA

Kit: No Kit

Pan Bolts: NA

OE: 8626876, 8627509

Governor Filter



GM 4T60, TH440

1983-1993

Filter: 515143

Gasket: Cork: 03G141, Nitrile: 22G141

Kit: 7143

Pan Bolts: 19

OE: 24228949, 24228950, 8658075,

8662943, 8675989, 8689918

(Replaces 515141)



GM 4T60E

1991-ON

Filter: 514347

Gasket: NA

Kit: No Kit

Pan Bolts: NA

OE: 8651754

Servo Filter



GM 4T60E

1991-ON

Filter: 514346

Gasket: NA

Kit: No Kit

Pan Bolts: NA

OE: 8651658

Sol., Force M. Torque Filter

**GM 4T60E, 4T65E****1991-ON****Filter:** 515142**Gasket:** Cork: 03G142, Reusable w/metal torque limiters: 14G142, Nitrile: 22G142**Kit:** 7142**Pan Bolts:** 20**OE:** 24206433, 24227477, 8651651, 8651909**GM 4T80E****1993-ON****Filter:** 514375**Gasket:** NA**Kit:** No Kit**Pan Bolts:** NA**OE:** 8680389

Shift Pressure Control

**GM 4T80E****1993-ON****Filter:** 515680**Gasket:** Cork: 03G682, Reusable w/metal torque limiters: 14G682, Nitrile: 22G682**Kit:** 7682**Pan Bolts:** 16**OE:** 24207361, 8680700

Left Scavenger (Bent)

**GM 4T80E****1993-ON****Filter:** 515681**Gasket:** Cork: 03G682, Reusable w/metal torque limiters: 14G682, Nitrile: 22G682**Kit:** 7682**Pan Bolts:** 16**OE:** 8679416

Right Scavenger (Straight)

**GM 4T80E****1993-ON****Filter:** 515683**Gasket:** NA**Kit:** No Kit, Disassembly**Pan Bolts:** 16**OE:** 8681416

Internal (Requires Disassembly)

**GM 5L40E, 5L50E****1999-ON****Filter:** 515690**Gasket:** Cork: 03G978, Reusable w/metal torque limiters: 14G978, Nitrile: 22G978**Kit:** 7690**Pan Bolts:** 22**OE:** 24117-510-011, 96041844

With Short Tabs



GM 5L40E, 5L50E

1999-ON

Filter: 515691

Gasket: Cork: 03G978, Reusable w/metal torque limiters: 14G978, Nitrile: 22G978

Kit: 7691

Pan Bolts: 22

OE: 24117-510-012, 24117-533-699, 24117-557-070, 96042545

With Long Tabs, Plastic Shroud



GM 5L40E, 5L50E

1999-ON

Filter: 515978

Gasket: Cork: 03G978, Reusable w/metal torque limiters: 14G978, Nitrile: 22G978

Kit: 7978

Pan Bolts: 22

OE: 2411-1-423-604, 24111-423-604, 24722100, 96042795

With Long Tabs



GM 6L45E

2007-ON

Filter: 515993

Gasket: Cork: 03G708, Reusable w/metal torque limiters: 14G708, Nitrile: 22G708

Kit: 7993

Pan Bolts: 18

OE: 24117-593-565, 24236595



GM 6L50, 6L80

2006-ON

Filter: 515698

Gasket: Reusable w/metal torque limiters: 14G698

Kit: 7698

Pan Bolts: 17

OE: 24250364, 24251707, 24258268

With 4.75" Neck, Flat Inlet, Tab Spacer Height 1.003"



GM 6L80

2006-ON

Filter: 515711

Gasket: Cork: 03G711, Reusable w/metal torque limiters: 14G711, Nitrile: 22G711

Kit: 7711

Pan Bolts: 18

OE: 24236518, 24236931

With 4.75" Neck, Inlet Length 1.9"



GM 6L80 (Police Patrol Vehicle Only)

2011-ON

Filter: 515710

Gasket: Cork: 03G708, Reusable w/metal torque limiters: 14G708, Nitrile: 22G708

Kit: 7710

Pan Bolts: 18

OE: 24235900, 24236932, 24251054, 24252158

With 4.25" Neck, PPV, Inlet Length 1.778", Tab Spacer Height .592"

**GM 6L80, 6L90****2006-ON**

Filter: 515709

Gasket: Cork: 03G708, Reusable w/metal torque limiters: 14G708, Nitrile: 22G708

Kit: 7709

Pan Bolts: 18

OE: 24236517, 24236933

With 4.73" Neck, Inlet Length 2.5", Tab Spacer Height 1.267"

**GM 6L90 (Camaro V8 6.2L)****2013-ON**

Filter: 515695

Gasket: Cork: 03G711, Reusable w/metal torque limiters: 14G711, Nitrile: 22G711

Kit: 7695

Pan Bolts: 18

OE: 24258269

Inlet Length .478", Tab Spacer Height 1"

**GM 6T30 / MH9****2012-ON**

Filter: 515188

Gasket: NA

Kit: No Kit, Disassembly

Pan Bolts: NA

OE: 24261229 (KIT)

**GM 6T40, 6T45****2008-2011**

Filter: 515699

Gasket: NA

Kit: No Kit, Disassembly

Pan Bolts: NA

OE: 24230708, 24246194

**GM 6T40/45/50 GEN 3****2014-ON**

Filter: 515696

Gasket: NA

Kit: No Kit, Disassembly

Pan Bolts: NA

OE: 24274649

No seal at this time

**GM 8L45, 8L90****2015-ON**

Filter: 515685

Gasket: Reusable w/metal torque limiters: 14G685, Nitrile: 22G685

Kit: 7685

Pan Bolts: 15

OE: 24268875, 24274402



GM 10L80, 10L90

2018-ON

Filter: 515290

Gasket: Reusable w/metal torque limiters:
14G290

Kit: 7290

Pan Bolts: 16

OE: 24273800 (As marked on filter)

Sump Filter



GM AF50-8, TG-81C

2016-ON

Filter: 515150

Gasket: NA

Kit: No Kit, Disassembly

Pan Bolts: NA

OE: 24276543

Sump Filter



GM POWERGLIDE

1962-1973

Filter: 515541

Gasket: Cork: 03G542, Nitrile: 22G542

Kit: 7541

Pan Bolts: 14

OE: 347096, 3849968, 6263005

Square Design



GM POWERGLIDE

1962-1973

Filter: 515542

Gasket: Cork: 03G542, Nitrile: 22G542

Kit: 7542

Pan Bolts: 14

OE: 347096, 3849968, 6263005

Rectangular Design



GM ST300

1964-1969

Filter: 515435

Gasket: Nitrile: 22G542

Kit: 7435

Pan Bolts: 14

OE: 1243385, 1374649



GM TH200

1976-1987

Filter: 514320

Gasket: NA

Kit: No Kit

Pan Bolts: NA

OE: 8664811

Aux. Box Filter

**GM TH200, M-29 (early)****1976-1979**

Filter: 515591

Gasket: Cork: 03G591, Nitrile: 22G591

Kit: 7591

Pan Bolts: 11

OE: 25010411, 8628299, 8628935

Brass

**GM TH200, TH200C (MV-9)****1979-1987**

Filter: 515437

Gasket: Cork: 03G591, Nitrile: 22G591

Kit: 7437

Pan Bolts: 11

OE: 8-08632949-9, 8630789, 8632949,

8638960

Deep Pan

**GM TH200-4R, TH325, TH325-4L****1979-1981**

Filter: 515324

Gasket: Cork: 03G324, Nitrile: 22G324

Kit: 7324

Pan Bolts: 15

OE: 8632095, 8632630, 8632996

**GM TH200-4R, TH325, TH325-4L****1981-1990**

Filter: 515439

Gasket: Cork: 03G439, 63G439, Nitrile: 22G439

Kit: 7439

Pan Bolts: 16

OE: 8634223, 8634931, 8639951

With Lipseal

**GM TH325-4L (M57)****1982-1985**

Filter: 515325

Gasket: Cork: 03G324, Nitrile: 22G324

Kit: 7325

Pan Bolts: 15

OE: 8635710, 8635981, 8645166

**GM TH350****1969-1986**

Filter: 515415

Gasket: Cork: 03G615, 63G615, Nitrile: 22G615

Kit: 7415

Pan Bolts: 13

OE: 347302, 6258504, 6261412, 6438816

Brass (Without Gasket)



GM TH350

1969-1986

Filter: 515615

Gasket: Cork: 03G615, 63G615, Nitrile: 22G615

Kit: 7615

Pan Bolts: 13

OE: 8640848

Nylon, Metal



GM TH350

1979-1982

Filter: 515616

Gasket: Cork: 03G615, 63G615, Nitrile: 22G615

Kit: 7616

Pan Bolts: 13

OE: 1246418, 8641443, 8641910

Felt



GM TH350

1969-1986

Filter: 514350

Gasket: NA

Kit: No Kit

Pan Bolts: NA

OE: 6273259, 6273269

Governor Screen - obsolete, use 514371



GM TH350

1969-1986

Filter: 514351

Gasket: NA

Kit: No Kit

Pan Bolts: NA

OE: 8640074

Pump Pressure Screen

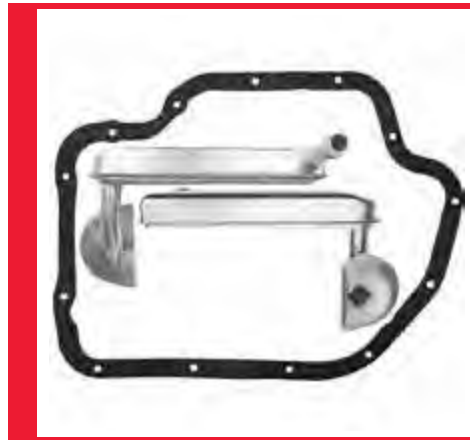

GM TH400 (Early)

1964-1967

Filter: 515434

Gasket: Cork: 03G533, 63G533, Nitrile: 22G533

Kit: 7434

Pan Bolts: 13

OE: 5579822



GM TH400 (Late HP)

1967-1990

Filter: 515532

Gasket: Cork: 03G532, 63G532, Nitrile: 22G532

Kit: 7532

Pan Bolts: 21

OE: 12337210, 29506392D, 29540976, 6438326, 6884270

Stainless

**GM TH400 (Late)****1967-1990**

Filter: 515533

Gasket: Cork: 03G533, 63G533, Nitrile: 22G533

Kit: 7533

Pan Bolts: 13

OE: 12337210, 12360651, 24210386, 6259423, 6437741, 6438348, AAU6690

Felt

**GM TH400 (Late)****1967-1990**

Filter: 515732

Gasket: Cork: 03G533, 63G533, Nitrile: 22G533

Kit: 7732

Pan Bolts: 21

OE: 1878301862, 29503617, 29506392, 94058636

Brass

**GM TH425****1966-1978**

Filter: 515534

Gasket: Cork: 03G534, 63G534, Nitrile: 22G534

Kit: 7534

Pan Bolts: 13

OE: 6435766, 6438301, 6438336

**GM TH700-R4****1982-ON**

Filter: 514302

Gasket: NA

Kit: No Kit

Pan Bolts: NA

OE: NA

**GM TH700-R4 (Late)****1982-1993**

Filter: 515700

Gasket: Cork: 03G700, 63G700, Nitrile: 22G700

Kit: 7700

Pan Bolts: 16

OE: 8642933, 8657926, 8667293

**GM TH700-R4, 4L60****1982-ON**

Filter: 514370

Gasket: NA

Kit: No Kit

Pan Bolts: NA

OE: 24210086, 8642036

Pump / Valve Body



GM TH700-R4, 4L60

1982-ON

Filter: 514371

Gasket: NA

Kit: No Kit

Pan Bolts: NA

OE: 8642423

Governor Filter



**GM / SATURN GM CVT VT-20
(Saturn Vue)**

2002-2005

Filter: 515548

Gasket: NA

Kit: No Kit, Disassembly

Pan Bolts: NA

OE: 24226576



GM / SATURN TAAT

1991-ON

Filter: 515549

Gasket: NA

Kit: No Kit

Pan Bolts: NA

OE: 21002346, 21002496

Internal (Disassembly Required)



GM / SATURN TAAT

1991-ON

Filter: 515550

Gasket: NA

Kit: No Kit

Pan Bolts: NA

OE: 21002303, 21003298, 21003361

External Spin-on



GM / SATURN TAAT

1991-ON

Filter: 514390

Gasket: NA

Kit: No Kit

Pan Bolts: NA

OE: 21002096

Flushing Filter



GM / SATURN TAAT

1991-ON

Filter: 514391

Gasket: NA

Kit: No Kit

Pan Bolts: NA

OE: 21002151



**HONDA / ACURA 2 SPEED
HONDAMATIC**

1973-1980

Filter: 515803

Gasket: NA

Kit: No Kit, Disassembly

Pan Bolts: NA

OE: 25420-639-000



**HONDA / ACURA 3 SPEED
HONDAMATIC**

1980-1985

Filter: 515805

Gasket: NA

Kit: No Kit, Disassembly

Pan Bolts: NA

OE: 25420-PA9-000

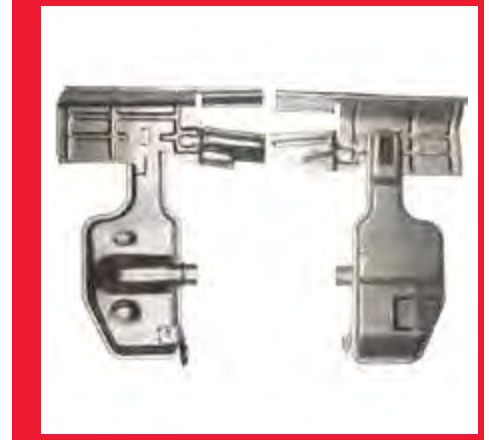

**HONDA / ACURA 4 SPEED A0YA,
APXA, APX4, B0YA, MP0A,
MPWA, MPXA, MP1A, MPJA,
PX4B**

1992-1997

Filter: 515951

Gasket: NA

Kit: No Kit, Disassembly

Pan Bolts: NA

OE: 25420-PX4-701, 5-86202512-0



**HONDA / ACURA 4 SPEED A24A,
A2YA, A4RA, B4RA, B46A, BDRA,
M24A, M4RA, S24A, S4RA**

1992-1995

Filter: 515959

Gasket: NA

Kit: No Kit, Disassembly

Pan Bolts: NA

OE: 25420-P24-J00, 25420-P24-J01



**HONDA / ACURA 4 SPEED A24A,
A2YA, A4RA, B4RA, B46A, BDRA,
M24A, M4RA, S24A, S4RA (99-00),
M4TA, MDLA, MDMA, MP7A, S4XA,
SDMA, SKWA, SP7A (99-01), BMXA,
SLXA (01-05)**

1999-2000

Filter: 515991

Gasket: NA

Kit: No Kit, Disassembly

Pan Bolts: NA

OE: 25420-P4R-013

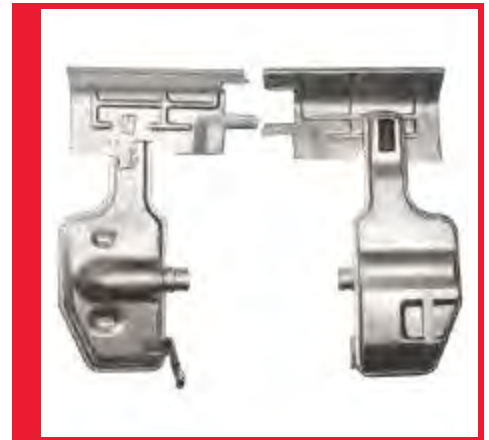

**HONDA / ACURA 4 SPEED A6VA,
A0YA, APXA, APX4, B0YA, MP0A,
MPWA, MPXA, MP1A, MPJA,
PX4B**

1990-1991

Filter: 515950

Gasket: NA

Kit: No Kit, Disassembly

Pan Bolts: NA

OE: 25420-PX4-023



**HONDA / ACURA 4 SPEED AK,
AS, CA (Integra), F4, G4, L5,
PL5X**

1983-1989

Filter: 515806

Gasket: NA

Kit: No Kit, Disassembly

Pan Bolts: NA

OE: 25420-PC9-000, 25420-PC9-010,
25420-PN6-700



**HONDA / ACURA 4 SPEED B7TA,
B7VA, B7YA, B7XA, B7ZA, M7ZA**
1999-2002

Filter: 515953

Gasket: NA

Kit: No Kit, Disassembly

Pan Bolts: NA

OE: 25420-P7X-003



**HONDA / ACURA 4 SPEED BAXA
(97-02), B6VA (98-99), M6HA,
MAXA, MDWA**

1997-2002

Filter: 515952

Gasket: NA

Kit: No Kit, Disassembly

Pan Bolts: NA

OE: 25420-P6H-000, 25420-PAX-003



**HONDA / ACURA 4 SPEED CA,
L4, M48A, ML4A, P1**

1988-1991

Filter: 515855

Gasket: NA

Kit: No Kit, Disassembly

Pan Bolts: NA

OE: 25420-PL4-000, 25420-PL4-010



**HONDA / ACURA 4 SPEED G4,
L5, PL5X, MPSA, S5**

1987-1991

Filter: 515856

Gasket: NA

Kit: No Kit, Disassembly

Pan Bolts: NA

OE: 25420-PL5-000



**HONDA / ACURA 4 SPEED K4,
MY8A, PY8A**

1990

Filter: 515958

Gasket: NA

Kit: No Kit, Disassembly

Pan Bolts: NA

OE: 25420-PY8-J10



HONDA / ACURA 4 SPEED K4, MY8A, PY8A

1988

Filter: 515957

Gasket: NA

Kit: No Kit, Disassembly

Pan Bolts: NA

OE: 25420-PK4-000



HONDA / ACURA 4 SPEED M4TA, MDLA, MDMA, MP7A, S4XA, SDMA, SKWA, SP7A (94-99), A24A, A2YA, A4RA, B4RA, B46A, BDRA, M24A, M4RA, S24A, S4RA (96-98)

1994-1999

Filter: 515960

Gasket: NA

Kit: No Kit, Disassembly

Pan Bolts: NA

OE: 25420-P56-003, 25420-P56-013

Integra 94-99, CR-V 94-98



HONDA / ACURA 4 SPEED M4TA, MDLA, MDMA, MP7A, S4XA, SDMA, SKWA, SP7A (CR-V), A24A, A2YA, A4RA, B4RA, B46A, BDRA, M24A, M4RA, S24A, S4RA (CR-V), BMXA, SLXA (CR-V)

1994-2005

Filter: 515956

Gasket: NA

Kit: No Kit, Disassembly

Pan Bolts: NA

OE: 25420-P4R-003, 25420-P4R-013



HONDA / ACURA 4 SPEED M5HA, M5DA, MPYA

1991-2004

Filter: 515857

Gasket: Cork: 03G857, Nitrile: 22G857

Kit: 7857

Pan Bolts: 14

OE: 25420-PY4-000



HONDA / ACURA 4 SPEED MCVA, MRVA (02-04), BZKA (03-05), MZKA (03-06), BC/MCLA, BZHA/JA/NA, GPLA/PA, MKYA/ZA, MRMA, MZHA/JA, MM7A, MNZA, MZKA, M8SA, MCTA

2002-2008

Filter: 515962

Gasket: NA

Kit: No Kit, Disassembly

Pan Bolts: NA

OE: 25420-PRP-003



HONDA / ACURA 4 SPEED MPRA, R0

1990-1993

Filter: 515965

Gasket: NA

Kit: No Kit, Disassembly

Pan Bolts: NA

OE: 25420-PR0-030

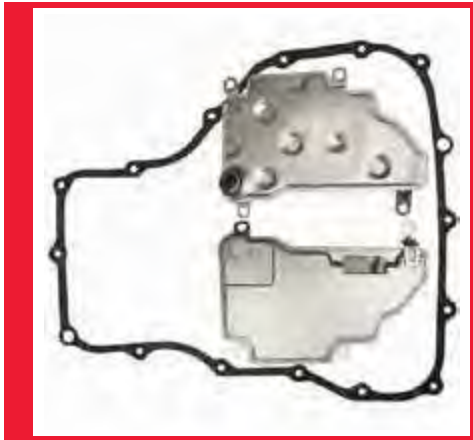

**HONDA / ACURA 4 SPEED MPWA
ACURA Vigor (92-94), M1WA (95-98)**

1992-1998

Filter: 515858

Gasket: Cork: 03G858, Nitrile: 22G858

Kit: 7858

Pan Bolts: 16

OE: 25420-PW4-010



**HONDA / ACURA 4 SPEED MR9A
1991-2005**

Filter: 515961

Gasket: NA

Kit: No Kit, Disassembly

Pan Bolts: NA

OE: 25420-PR9-020



**HONDA / ACURA 5 SPEED B/
M7WA, MGFA (00-03), BGFA (02-03), M/BAYA (03-07), BDGA (04-06), BYBA, BGHA, MGHA (01-04)**

2000-2005

Filter: 515966

Gasket: NA

Kit: No Kit, Disassembly

Pan Bolts: NA

OE: 25420-P7W-003

Internal



**HONDA / ACURA 5 SPEED BBSA,
BBTA (Crosstour), 6 SPEED Acura
MDX, RL, TL, ZDX, PYRA MV2A
(Odyssey Touring)**

2010-ON

Filter: 515729

Gasket: NA

Kit: No Kit, Disassembly

Pan Bolts: NA

OE: 25420-RV2-003

35mm Pickup Tube



**HONDA / ACURA 5 SPEED BDKA,
MDKA (MDX) (03-06), BJFA,
MJBA (Ridgeline) (06-08)**

2003-2008

Filter: 515967

Gasket: NA

Kit: No Kit, Disassembly

Pan Bolts: NA

OE: 25420-RDK-013



**HONDA / ACURA 5 SPEED BGHA,
BYBA, MGHA**

2001-2004

Filter: 515947

Gasket: NA

Kit: No Kit

Pan Bolts: NA

OE: 25450-P7W-003

Spin-on



HONDA / ACURA 5 SPEED BGRA, BVGA (Element)

2003-2006

Filter: 515946

Gasket: NA

Kit: No Kit

Pan Bolts: NA

OE: 25450-RAY-003



HONDA / ACURA 5 SPEED BJFA (Ridgeline) PSFA (Ridgeline), PN3A (4WD) (Pilot), BBTA (Crosstour)

2005-2011

Filter: 515791

Gasket: NA

Kit: No Kit, Disassembly

Pan Bolts: NA

OE: 25420-RN3-003

Internal Filter



HONDA / ACURA 5 SPEED BRZA, 6 SPEED MT4A, M7PA, PYRA

2006-ON

Filter: 515788

Gasket: NA

Kit: No Kit

Pan Bolts: NA

OE: 25430-PLR-003

In Line Filter



HONDA / ACURA 5 SPEED BRZA, MZ2A, MPCA, SPCA, MP5A, SMMA, SP5A

2006-ON

Filter: 515948

Gasket: NA

Kit: No Kit

Pan Bolts: NA

OE: 25420-RPC-003



HONDA / ACURA 5 SPEED BVGA (Pilot EX)

2005-2006

Filter: 515969

Gasket: NA

Kit: No Kit

Pan Bolts: NA

OE: 25420-RDP-003

Internal/Sump Filter



HONDA / ACURA 5 SPEED BVGA (Pilot Main)

2002-2005

Filter: 515954

Gasket: NA

Kit: No Kit, Disassembly

Pan Bolts: NA

OE: 25420-PGH-003



HONDA / ACURA 5 SPEED BYFA, MJBA, BWEA, BT3A

2005-2012

Filter: 515790

Gasket: NA

Kit: No Kit, Disassembly

Pan Bolts: NA

OE: 25420-RWE-004, 25420-RWE-014



HONDA / ACURA 5 SPEED M8SA (Acura TSX), B90A, M91A, B5RA, B5SA

2007-ON

Filter: 515728

Gasket: NA

Kit: No Kit, Disassembly

Pan Bolts: NA

OE: 25420-RXH-003



HONDA / ACURA 5 SPEED MJBA (Acura RL)

2005-2008

Filter: 515789

Gasket: NA

Kit: No Kit, Disassembly

Pan Bolts: NA

OE: 25420-RJB-004



HONDA / ACURA 5 SPEED PN4A (2WD), B36A, P36A, PV1A (2WD Main), B97A, BDHA, BDGA

2007-2011

Filter: 515898

Gasket: NA

Kit: No Kit

Pan Bolts: NA

OE: 25420-R36-003



HONDA / ACURA 5 SPEED SMMA, CVT SWRA (Honda Jazz Overseas)

2004-ON

Filter: 515727

Gasket: NA

Kit: No Kit, Disassembly

Pan Bolts: NA

OE: 25420-PWR-003



HONDA / ACURA 6 SPEED MT4A, M7PA, M8EA (Acura MDX, ZDX, RL)

2010-2011

Filter: 515995

Gasket: NA

Kit: No Kit, Disassembly

Pan Bolts: NA

OE: 25420-RT4-004

27mm Pickup Tube



HONDA / ACURA B36A, B97A, B98A, BV1A, BDHA, BDGA, BGRA, BK3A, BK4A, BLJA, BLKA, BYFA, M4VA, MHTA, MJBA, MJBA, MM2A, MURA, P36A, P79A, PGRA, PN3A, PN4A, P36A

1996-2016

Filter: 515955

Gasket: NA

Kit: 7955

Pan Bolts: NA

OE: 25450-P4V-013, 25450-PAV-003



HONDA / ACURA CVT M4VA

1996-2000

Filter: 515964

Gasket: NA

Kit: No Kit

Pan Bolts: 14

OE: 25420-P4V-003



HONDA / ACURA CVT M4VA (Civic HX)

1996-2000

Filter: 515899

Gasket: NA

Kit: No Kit, Disassembly

Pan Bolts: NA

OE: 25420-PET-003



HONDA / ACURA CVT MHTA, SZCA

2003-2005

Filter: 515992

Gasket: NA

Kit: No Kit, Disassembly

Pan Bolts: NA

OE: 25420-PHT-003

Filter - Main (Civic Hybrid)



HONDA / ACURA CVT SLYA, MLYA

2001-2005

Filter: 515968

Gasket: Nitrile: 22G968

Kit: 7968

Pan Bolts: 14

OE: 25420-PLY-003



HONDA / ACURA CVT SWRA

2001-ON

Filter: 515726

Gasket: NA

Kit: No Kit

Pan Bolts: NA

OE: 25450-PWR-003

Cartridge



HYUNDAI A4BF3 (Accent 2000-2003, Elantra 2000, Tiburon 6/1999-2001)

1999-ON

Filter: 515932

Gasket: Cork: 03G930, 63G930, 63G931,

Nitrile: 22G930, 22G931

Kit: 7932

Pan Bolts: 13

OE: 46321-22731



HYUNDAI / KIA A4CF1, A4CF2
10/02-1/08

Filter: 515933

Gasket: NA

Kit: 7933

Pan Bolts: NA

OE: 46321-23000



HYUNDAI / KIA A4CF1, A4CF2, A5CF1, A5CF2

2008-ON

Filter: 515339

Gasket: NA

Kit: No Kit

Pan Bolts: 19

OE: 46321-23001



HYUNDAI / KIA A5GF1, A5HF1

2005-ON

Filter: 515881

Gasket: Nitrile: 22G881

Kit: 7881

Pan Bolts: 14

OE: 46321-39010



HYUNDAI / KIA A6GF1

2009-ON

Filter: 515336

Gasket: NA

Kit: No Kit, Disassembly

Pan Bolts: NA

OE: 46321-26000

Replaces 515338



HYUNDAI / KIA A6LF1, A6LF2

2009-ON

Filter: 515337

Gasket: NA

Kit: No Kit, Disassembly

Pan Bolts: NA

OE: 46321-3B000



**HYUNDAI / KIA A8TR1 / A8LR1
2011-ON**

Filter: 515335
 Gasket: Gasket included With Pan/Filter
 Kit: No Kit
 Pan Bolts: 14
 OE: 45280-4E020, 45280-4E000, 45280-4E001



ISUZU / MAZDA JR405E, RC4A-EL

2004-2009
 Filter: 515797
 Gasket: NA
 Kit: No Kit
 Pan Bolts: NA
 OE: 897-331-0630



**JATCO JF402E, JF405E
1999-2007**

Filter: 515894
 Gasket: Nitrile: 22G894
 Kit: 7894
 Pan Bolts: 13
 OE: 45611-02700



JATCO JF403E (Geo Storm, Isuzu Impulse)

1990-ON
 Filter: 515189
 Gasket: Cork: 03G189, Nitrile: 22G189
 Kit: 7189
 Pan Bolts: 21
 OE: 8-94385937-0, 8-94428489-0, 94385937



**MAZDA F3A, KF100 (MX-1), ATX
1981-1986**

Filter: 515807
 Gasket: Cork: 03G807, 03G190, Nitrile: 22G190
 Kit: 7807
 Pan Bolts: 17/18
 OE: 941140860, 94140860, FT01-19-815
 With Shallow Pan



MAZDA F3A, KF100 (MX-1), ATX (Ford Aspire)

1994-1997
 Filter: 515191
 Gasket: Cork: 03G190, 03G191, Nitrile: 22G190
 Kit: 7191
 Pan Bolts: 17/16
 OE: F4BZ-7A098-A, F4BZ-7A098-AA



MAZDA F3A, KF100 (MX-1), ATX (Spectrum, Isuzu)

1987-1993

Filter: 515190

Gasket: Cork: 03G807, 03G190, Nitrile: 22G190

Kit: 7190

Pan Bolts: 17/18

OE: 94428489



MAZDA F3A, KF100 (MX-1), ATX (Tracer, Festiva)

1989-1993

Filter: 515592

Gasket: Cork: 03G191

Kit: 7592

Pan Bolts: 16

OE: E9BZ-7A098-A, E9BZ-7A098-AA



MAZDA F3A, KF100 (MX-1), ATX (Tracer, Festiva)

1986-1989

Filter: 515845

Gasket: Cork: 03G190, 03G191, Nitrile: 22G190

Kit: 7845

Pan Bolts: 17/16

OE: E7GZ-7A098-A, FT21-19-815C, FT21-19-815D



MAZDA FW6A-EL

2013-ON

Filter: 515740

Gasket: Nitrile: 22G740

Kit: 7740

Pan Bolts: 16

OE: FZ01-21-500



MAZDA GM 17R

1985-1986

Filter: 515818

Gasket: Cork: 03G807

Kit: 7818

Pan Bolts: 18

OE: 31728-KF101, 8-94413-320-0, 8-94413320-0, 94413317, 94413320
With Deep Pan



MAZDA LJ4A-EL

1995-ON

Filter: 515872

Gasket: Nitrile: 22G872

Kit: 7872

Pan Bolts: 17

OE: FX01-19-815



MAZDA N4AEL, N4AHL

1988-ON

Filter: 515823

Gasket: Cork: 03G416, 63G416, Nitrile: 22G416

Kit: 7823

Pan Bolts: 14

OE: 31728-X8600, MD610736



MAZDA R4A-EL

1990-1999

Filter: 515840

Gasket: 22G838, 03G838

Kit: 7840

Pan Bolts: 18

OE: 31728-41X01, 31728-41X03, 8-94483567-7, BV11-19-815

1" Tube



MAZDA R4A-EL

1993-1996

Filter: 515874

Gasket: Cork: 03G838, Nitrile: 22G838

Kit: 7874

Pan Bolts: 18

OE: BV65-19-815

1.825" Tube



MAZDA R4A-EL

1990-1999

Filter: 515945

Gasket: Cork: 03G838, Nitrile: 22G838

Kit: 7945

Pan Bolts: 18

OE: BV56-19-815, BV92-19-815

.825" Tube



MAZDA / VOLKSWAGEN / AUDI / JAGUAR / FORD / NISSAN JF506E, 5F31, 5F31J, 09A, AG5, RE5F01A

2001-ON

Filter: 515876

Gasket: Nitrile: 22G876

Kit: 7876

Pan Bolts: 20

OE: 31728-PW003

(Ford Galaxy, VW Sharran, Seat Alhambra)



MAZDA / VOLKSWAGEN / AUDI / JAGUAR / FORD / NISSAN JF506E, 5F31, 5F31J, 09A, AG5, RE5F01A

2001-ON

Filter: 515877

Gasket: Nitrile: 22G876

Kit: 7877

Pan Bolts: 20

OE: 09A-325-429, 09A-325-429A

(VW Golf, Ford Mondeo, Mazda)



**MAZDA / VOLKSWAGEN / AUDI
/ JAGUAR / FORD / NISSAN
JF506E, 5F31, 5F31J, 09A, AG5,
RE5F01A**

2001-ON

Filter: 515878

Gasket: Nitrile: 22G876

Kit: 7878

Pan Bolts: 20

OE: 96042795, FP01-21-500

(Rover 75, Jaguar X Type, Land Rover Freelander)



MERCEDES 722.9

2005-2010

Filter: 515986

Gasket: Molded Rubber: 04G986

Kit: 7986

Pan Bolts: NA

OE: 220-277-0395, 220-277-0695, 221-

277-0095, 221-277-0195



MERCEDES 722.9

2011-ON

Filter: 515748

Gasket: Molded Rubber: 04G986

Kit: NA

Pan Bolts: NA

OE: 222-277-20-00, 221-277-00-00, 221-

277-01-00



MERCEDES 722.0, 722.1, 722.2

1970-1983

Filter: 515865

Gasket: Molded Rubber: 04G865

Kit: 7864

Pan Bolts: 4

OE: 115-270-0398, 115-270-0495

Without Tube



MERCEDES 722.0, 722.1, 722.2

1970-1983

Filter: 515866

Gasket: 04G865

Kit: 7866

Pan Bolts: 4

OE: 123-270-0098

With 1" Long Tube



MERCEDES 722.0, 722.1, 722.2

1970-1983

Filter: 515867

Gasket: 04G865

Kit: 7867

Pan Bolts: 4

OE: 109-270-0298, 109-277-0195

With .75" Long Tube



**MERCEDES 722.3 (W4A040)
1981-1997**

Filter: 515988
Gasket: 04G868
Kit: 7988
Pan Bolts: 6
OE: 460-277-0195
With 1" Long Tube



**MERCEDES 722.3 (W4A040),
722.4 (W4A020)**

1981-1997
Filter: 515868
Gasket: 04G868
Kit: 7868
Pan Bolts: 6
OE: 126-277-0295
No Tube



**MERCEDES 722.5 (W5A030)
1990-1997**

Filter: 515864
Gasket: 04G868
Kit: 7864
Pan Bolts: 6
OE: 129-277-0095, 129-277-0195
With Sliding Valve



**MERCEDES 722.6 (W5A330,
W5A580)**

1996-2006
Filter: 515870
Gasket: 04G870
Kit: 7870
Pan Bolts: 6
OE: 140-272-0095, 140-277-0095,
52108325AA, BU01-19-815, JLM20470



**PORSCHE / MERCEDES 722.6
Tiptronic**

2001-2009
Filter: 515445
Gasket: Molded Rubber: 04G870
Kit: No Kit
Pan Bolts: NA
OE: 722-277-0095



**MERCEDES 722.7 (W5A180)
1998-ON**

Filter: 515985
Gasket: NA
Kit: No Kit
Pan Bolts: NA
OE: 168-377-0295, 168-377-0395



MERCEDES 724.003 (7G DCT)

2012-ON

Filter: 515750

Gasket: 14G750

Kit: No Kit

Pan Bolts: 8

OE: 246-377-03-95, 246-377-14-00, 246-377-24-00



MITSUBISHI 6 SPEED JF613E

2007-ON

Filter: 515349

Gasket: NA

Kit: No Kit, Disassembly

Pan Bolts: NA

OE: 2824A007



MITSUBISHI A4AF-1 (Hyundai)

2000-ON

Filter: 515932

Gasket: Cork: 03G930, 63G930, 63G931,
Nitrile: 22G930, 22G931

Kit: 7932

Pan Bolts: 13

OE: 46321-22731



MITSUBISHI F4A32-1

1991-ON

Filter: 515863

Gasket: Cork: 03G863, 63G863, Nitrile:
22G863

Kit: 7863

Pan Bolts: 14

OE: 46321-38000, MD735572



MITSUBISHI F4A33-1

1991-ON

Filter: 515963

Gasket: Cork: 03G863, 63G863, Nitrile:
22G863

Kit: 7963

Pan Bolts: 14

OE: 46321-38010



MITSUBISHI F4A41, F4A42 (Except Sonata)

1997-2008

Filter: 515901

Gasket: NA

Kit: 7901, Disassembly

Pan Bolts: NA

OE: MD758691



MITSUBISHI F4A41, F4A42, F5A42, F4A51, F4A51-2, F4A5A, F5A51

1997-2009

Filter: 515900

Gasket: NA

Kit: No Kit

Pan Bolts: NA

OE: 46322-39000, MD752072

Spin On



MITSUBISHI F4A42 (Hyundai), A4CF1, A4CF2 (Kia)

2008-ON

Filter: 515339

Gasket: NA

Kit: 7339

Pan Bolts: 19

OE: 46321-23001



MITSUBISHI F4A42 (Hyundai), A4CF1, A4CF2 (Kia)

10/2002-1/2008

Filter: 515933

Gasket: NA

Kit: No Kit, Disassembly

Pan Bolts: NA

OE: 46321-23000



MITSUBISHI F4A42 (Sonata), F5A51 (Hyundai)

1997-2008

Filter: 515881

Gasket: Nitrile: 22G881

Kit: 7881

Pan Bolts: 14

OE: 46321-39010



MITSUBISHI F4A51

1997-4/1999

Filter: 515880

Gasket: NA

Kit: No Kit, Disassembly

Pan Bolts: NA

OE: MD758684



MITSUBISHI F4A51

5/99-2008

Filter: 515903

Gasket: NA

Kit: No Kit, Disassembly

Pan Bolts: NA

OE: MR350441



**MITSUBISHI KM 170 SERIES,
A4AF1, F4A32A, F4A-32-A,
W4A32A**

1982-1994

Filter: 515861

Gasket: Cork: 03G860, 63G860, 63G861,

Nitrile: 22G860, 22G861

Kit: 7861

Pan Bolts: 13/12

OE: 46321-36011, MD729955



**MITSUBISHI KM 170 SERIES,
A4AF1, F4A32A, F4A-32-A,
W4A32A**

1987-1998

Filter: 515862

Gasket: Cork: 03G860, 63G860, 63G861,

Nitrile: 22G860, 22G861

Kit: 7862

Pan Bolts: 13/12

OE: 46321-36001, 46321-36010, 737840,

94483567, MD673110, MD737840

Except KM 172, F4A33-1, W4A32-1



**MITSUBISHI KM 170 SERIES, A4AF1,
F4A32A, F4A-32-A, W4A32A (Hyundai
S Coupe, Accent)**

1993-ON

Filter: 515930

Gasket: Cork: 03G930, 63G930, 63G931,

Nitrile: 22G930, 22G931

Kit: 7930, 7931

Pan Bolts: 13

OE: 46321-22015, 46321-22040, 46321-

22050, MD673110

(Hyundai S Coupe, Accent)



MITSUBISHI KM170 (Early)

1979-1981

Filter: 515813

Gasket: Cork: 03G860, 63G860, Nitrile:

22G860

Kit: 7813

Pan Bolts: 12

OE: MD707786



MITSUBISHI KM170 (Late)

1982-1988

Filter: 515814

Gasket: Cork: 03G860, 63G860, Nitrile:

22G860

Kit: 7814

Pan Bolts: 12

OE: 45763-21700, MD707787, MD710056



MITSUBISHI KM175, KM177

1988-1992

Filter: 515860

Gasket: Cork: 03G860, 63G860, Nitrile:

22G860

Kit: 7860

Pan Bolts: 12

OE: MD729954



MITSUBISHI R4A51, V4A51, R5A51, V5A51

2001-2006

Filter: 515904

Gasket: Nitrile: 22G902

Kit: 7904

Pan Bolts: 20

OE: 46321-22040, MR528836

.5" Tube



MITSUBISHI R4A51, V4A51, R5A51, V5A51

1997-2000

Filter: 515902

Gasket: Nitrile: 22G902

Kit: 7902

Pan Bolts: 20

OE: MR357710

No Tube



MITSUBISHI R5M31 (Viryca)

2000-2002

Filter: 515905

Gasket: NA

Kit: No Kit, Disassembly

Pan Bolts: NA

OE: MR336180, MR567673



MITSUBISHI R5M31 (Viryca)

1999-ON

Filter: 515906

Gasket: NA

Kit: No Kit, Disassembly

Pan Bolts: NA

OE: MB919852



MITSUBISHI / HYUNDAI F1C1, CVT

2001-2009

Filter: 515882

Gasket: NA

Kit: No Kit, Disassembly

Pan Bolts: NA

OE: MR515064



NISSAN E4N71B

1988-1998

Filter: 515844

Gasket: Cork: 03G416, 63G416, Nitrile: 22G416

Kit: 7844

Pan Bolts: 14

OE: BV01-19-815



NISSAN L3N71B

1972-1994

Filter: 515416

Gasket: Cork: 03G416, 03G812, 63G416, Nitrile: 22G416

Kit: 7416, 7812

Pan Bolts: 14

OE: 0338-19-815, 31728-X0100, 31728-X0F00, D37Z-7A098-A, D37Z-7A098-B

With Internal Servo



NISSAN L3N71B

1974-1983

Filter: 515418

Gasket: Cork: 03G418, Nitrile: 22G418

Kit: 7418

Pan Bolts: 17

OE: 1758-19-815, D7DZ-7A098-A, D7DZ-7A098-B

With External Servo



NISSAN L3N71B

1986-1989

Filter: 515846

Gasket: Cork: 03G416, 63G416, Nitrile: 22G416

Kit: 7846

Pan Bolts: 14

OE: 31728-51X05, 31728-X0900, BT40-19-815A



NISSAN L4N71B

1983-1988

Filter: 515823

Gasket: Cork: 03G416, 63G416, Nitrile: 22G416

Kit: 7823

Pan Bolts: 14

OE: 31728-X8600, MD610736



NISSAN RE0F08A/B, JF009E CVT

2007-ON

Filter: 515508

Gasket: NA

Kit: No Kit

Pan Bolts: 15

OE: NA

Curved Inlet



NISSAN RE0F06A CVT

1996-2006

Filter: 515725

Gasket: Nitrile: 22G725

Kit: 7725

Pan Bolts: 20

OE: 31728-8E000



NISSAN RE0F10A /D, JF016E, JF011E CVT 8 W1CJC

2007-ON

Filter: 515495

Gasket: Nitrile: 22G495

Kit: 7495

Pan Bolts: 20

OE: 05191890AA, 5191890AA

Short Square Inlet



NISSAN RE0F10A /D, JF016E, JF011E CVT 8 W1CJC

2007-ON

Filter: 515497

Gasket: NA

Kit: No Kit

Pan Bolts: NA

OE: 31726-1XF00, 31726-1XZ0A

Cartridge



NISSAN RE0F10A /D, JF016E, JF011E CVT 8 W1CJC (4WD)

2007-ON

Filter: 515496

Gasket: Nitrile: 22G496

Kit: 7946

Pan Bolts: 21

OE: 31728-1XF03, 31728-1XZ0A

Sump Filter, Long Square Inlet



NISSAN RE4R03A

1989-2002

Filter: 515839

Gasket: Nitrile: 22G839

Kit: 7839

Pan Bolts: 18

OE: 31728-51X02, 31728-51X08

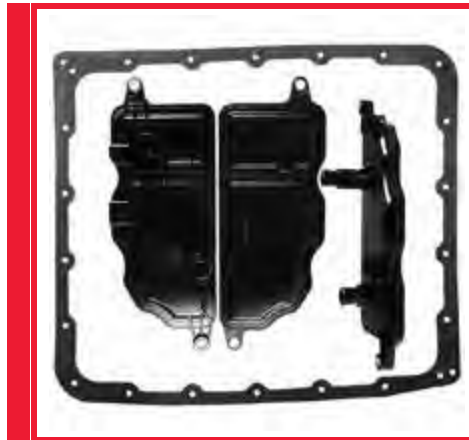

NISSAN RE5R05A

2004-2013

Filter: 515343

Gasket: Nitrile: 22G934

Kit: 7343

Pan Bolts: 22

OE: 31728-7S110, 31728-7S11A

Sump Filter



NISSAN RE5R05A

2002-ON

Filter: 515934

Gasket: Nitrile: 22G934

Kit: 7934

Pan Bolts: 22

OE: 31728-97X00



NISSAN RL3F01A (FWD)

1981-1986

Filter: 515808

Gasket: Cork: 03G808, 63G808, Nitrile: 22G808

Kit: 7808

Pan Bolts: 14

OE: 31728-01X09

Uniform .25" Inlet



NISSAN RL4F02A

1985-ON

Filter: 515842

Gasket: Nitrile: 22G842

Kit: 7842

Pan Bolts: 16

OE: 31728-21X00, 31728-21X01, 31728-21X02

RL4F02A



NISSAN RL4F03A (Sentra)

1991-ON

RE4R03A, RE4F03B, RE4F03V

Filter: 515837

Gasket: Cork: 03G837, Nitrile: 22G837

Kit: 7837

Pan Bolts: 21

OE: 31728-31X01



NISSAN RN3F01A (FWD)

1987-1992

Filter: 515841

Gasket: Cork: 03G808, 63G808, Nitrile: 22G808

Kit: 7841

Pan Bolts: 14

OE: 31728-01X10



NISSAN RN3F01A, RL3F01A

1978-1982

Filter: 515939

Gasket: Cork: 03G808, 63G808, Nitrile: 22G808

Kit: 7939

Pan Bolts: 14

OE: 31728-01X08

Graduated Inlet

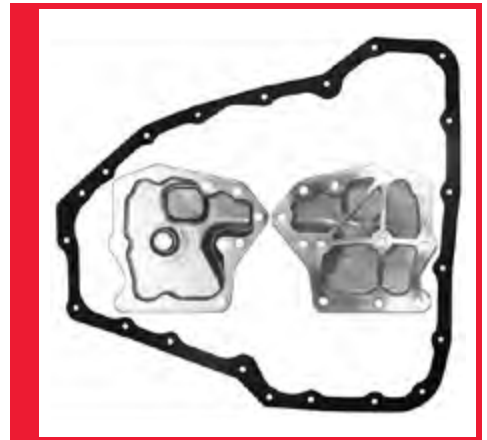

NISSAN / FORD RE4F04A

1999

Filter: 515936

Gasket: Cork: 03G937, Nitrile: 22G937

Kit: 7936

Pan Bolts: 21

OE: 31728-80X04



NISSAN / FORD RE4F04A

2002-ON

Filter: 515938

Gasket: Cork: 03G937, Nitrile: 22G937

Kit: 7938

Pan Bolts: 21

OE: 31728-85X01, 31728-85X0A



**NISSAN / FORD RE4F04A,
RE4F04V**

1992-ON

Filter: 515937

Gasket: Cork: 03G937, Nitrile: 22G937

Kit: 7937

Pan Bolts: 21

OE: 31728-80L01, 31728-80X03, 31728-80X04, F3XY-7A098-A, F3XY-7A098-AA, F7XY-7A098-AA



**NISSAN / INFINITI JF011E /
RE0F01A CVT**

2011-2017

Filter: 515499

Gasket: NA

Kit: No Kit

Pan Bolts: NA

OE: 31728-3TX0A

Round 1.5865" long inlet

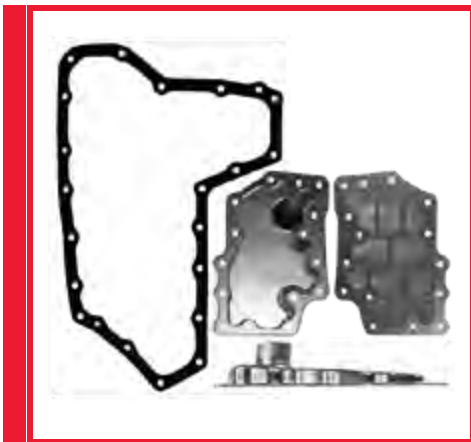

**NISSAN / INFINITI RE0F09A,
RE0F09B / JF010E ECVT**

2003-ON

Filter: 515498

Gasket: Nitrile: 22G498

Kit: 7498

Pan Bolts: 21

OE: F09-G28-403

Round Inlet



**NISSAN / INFINITI RE0F10E /
JF017E CVT 8 (4WD)**

2013-ON

Filter: 515787

Gasket: NA

Kit: No Kit

Pan Bolts: NA

OE: 31728-29X0A

Angled Inlet Length 1.848"



**NISSAN / INFINITI RE7R01A /
JR710E, JR711E**

2008-ON

Filter: 515785

Gasket: Nitrile: 22G785

Kit: 7785

Pan Bolts: 24

OE: NA



**NISSAN / INFINITI / SUZUKI
RE0F11A / JF015E CVT 7**

2010-2014

Filter: 515783
Gasket: NA
Kit: No Kit
Pan Bolts: NA
OE: 31726-3JX0A
Cartridge



**NISSAN / INFINITI / SUZUKI
RE0F11A / JF015E CVT 7**

2010-2014

Filter: 515784
Gasket: Nitrile: 22G784, Farpak: 05G784
Kit: 7784
Pan Bolts: 15
OE: 31728-3JX0A, 31728-3JX0B
Inlet Length 1.062"



**NISSAN / MAZDA R4AEL
(B2600), R4AEL (RX-7) (88-92)**

1988-1998

Filter: 515875
Gasket: NA
Kit: No Kit
Pan Bolts: NA
OE: BV50-19-815
Inlet Length 1.611", Inlet Height .710"



**NISSAN / MAZDA RE4R01A
(2WD) (Pathfinder, Pickup),
RG4R01A, JR403E (88-98)**

1987-2004

Filter: 515838
Gasket: Cork: 03G838, Nitrile: 22G838
Kit: 7838
Pan Bolts: 18
OE: 31728-41X00, 31728-41X02, 31728-41X04



**NISSAN / MAZDA RE4R01A
(4WD) (Pathfinder)**

1987-2004

Filter: 515840
Gasket: Cork: 03G838, Nitrile: 22G838
Kit: 7840
Pan Bolts: 18
OE: 31728-41X01, 31728-41X03,
8-94483567-7, BV11-19-815
Pickup, 1" Tube



**NISSAN / MAZDA RE4R01A
(R4AEL), RL4R01A, RE5R01A**

1988-1995

Filter: 515945
Gasket: Cork: 03G838, Nitrile: 22G838
Kit: 7945
Pan Bolts: 18
OE: BV56-19-815, BV92-19-815



NISSAN / MAZDA RE5R01A

1991-2000

Filter: 515884

Gasket: NA

Kit: No Kit

Pan Bolts: 18

OE: 31728-60X01

Inlet Length 1.574"



NISSAN / MAZDA RE5R01A (BMW)

1991-2000

Filter: 515935

Gasket: NA

Kit: No Kit

Pan Bolts: 18

OE: 24341-423-109, 31728-60X01

Inlet Length 1.696", Inlet Height .689"



NISSAN / MAZDA RL4R01A (2WD) (4 Cyl. Pickup)

1989-2004

Filter: 515940

Gasket: Cork: 03G838, Nitrile: 22G838

Kit: 7940

Pan Bolts: 18

OE: 31728-48X00, 31728-48X01

Inlet Length .125"



RENAULT AD4 (Scenic, CLI0)

1990-ON

Filter: 515720

Gasket: NA

Kit: No Kit

Pan Bolts: 4

OE: 7701-467-106



RENAULT AD8 (Safrane)

1993-ON

Filter: 515722

Gasket: NA

Kit: No Kit

Pan Bolts: 7

OE: 7701-467-878



RENAULT MB1, MJ1, MJ3, 4139 (Alliance, Encore)

1986-ON

Filter: 515715

Gasket: NA

Kit: No Kit

Pan Bolts: NA

OE: 7700-712-751, T0717533, T0727392



**RENAULT MB1, MJ1, MJ3, 4139
(Alliance, Encore)**

1983-1985

Filter: 515717

Gasket: NA

Kit: No Kit

Pan Bolts: NA

OE: 7700-712-571, 7700-723-787, 7700-723-943, 7700-734-655, T0712571, T0734655



**RENAULT MB1, MJ1, MJ3, 4139
(Eagle Medallion)**

1988-1989

Filter: 515718

Gasket: NA

Kit: No Kit

Pan Bolts: NA

OE: 7700-739-883, T0739883



**RENAULT MB1, MJ1, MJ3, 4139
(Eagle Medallion, Premier AR4)**

1988-1989

Filter: 515719

Gasket: NA

Kit: No Kit

Pan Bolts: NA

OE: 7700-746-294, J0746294, J1467103, T0741006



RENAULT / PEUGEOT DPO, AL4

1998-ON

Filter: 515721

Gasket: NA

Kit: No Kit, Disassembly

Pan Bolts: NA

OE: 7701-107-578



SUBARU 5 Speed, 5EAT

2005-ON

Filter: 515355

Gasket: Nitrile: 22G355

Kit: 7355

Pan Bolts: 21

OE: NA



SUBARU ECVT (Justy)

1989-1994

Filter: 515851

Gasket: Nitrile: 22G851

Kit: 7851

Pan Bolts: 13

OE: 31728-KA000, 31728-KA030, 31728-KA031



SUBARU M41, M41A

1975-ON

Filter: 515416

Gasket: Cork: 03G416, 63G416, Nitrile: 22G416

Kit: 7416

Pan Bolts: 14

OE: 0338-19-815, 31728-X0100, 31728-X0F00, D37Z-7A098-A, D37Z-7A098-B



**SUBARU R4AX-EL, 4EAT, EC-8
(Except Legacy, SVX, Loyale)**

1987-1991

Filter: 515850

Gasket: Cork: 03G850, Nitrile: 22G850

Kit: 7850

Pan Bolts: 20

OE: 31728-AA000

Inlet Height .125"



**SUBARU R4AX-EL, 4EAT, EC-8
(Legacy, Forester)**

1999-ON

Filter: 515854

Gasket: Nitrile: 22G854

Kit: 7854

Pan Bolts: 20

OE: 31728-AA050



**SUBARU R4AX-EL, 4EAT, EC-8
(Legacy, Forester)**

1999-ON

Filter: 515859

Gasket: NA

Kit: No Kit

Pan Bolts: NA

OE: 38325-AA030, 38325-AA031, 38325-AA032, 38325-KA000

Spin-on



**SUBARU R4AX-EL, 4EAT, EC-8
(Legacy, Forester, Impreza, Outback)**

2004-ON

Filter: 515883

Gasket: NA

Kit: No Kit

Pan Bolts: 20

OE: 31728-AA130



**SUBARU R4AX-EL, 4EAT, EC-8
(Legacy, SVX, Loyale)**

1990-1992

Filter: 515853

Gasket: Cork: 03G850, Nitrile: 22G850

Kit: 7853

Pan Bolts: 20

OE: 31728-AA010, 31728-AA011

Inlet Height .603"



SUBARU SB308 SB308 (Suzuki Corsa)

1988-ON

Filter: 515852

Gasket: NA

Kit: No Kit, Disassembly

Pan Bolts: NA

OE: 26570-78231



SUZUKI WAGON R SR410-2, SR412-2

1999-2003

Filter: 515892

Gasket: NA

Kit: No Kit

Pan Bolts: 16

OE: 26570-55A10



SUZUKI WAGON R SR410-2, SR412-2

1999-2003

Filter: 515893

Gasket: NA

Kit: No Kit

Pan Bolts: 16

OE: 26570-75F10



SUZUKI / NISSAN AW03-72LS, A44DE

2009-2013

Filter: 515380

Gasket: NA

Kit: No Kit

Pan Bolts: 14

OE: 26570-65D10



TOYOTA A130, A130L, A131A, A131L, A132L (Geo Prizm, Toyota Tercel, Corolla), A140E, A140L, A141E, A142E, A142L (Camry, Celica, MR2)

1983-ON

Filter: 515920

Gasket: Cork: 03G820, Nitrile: 22G820

Kit: 7920

Pan Bolts: 15

OE: 35330-20010, 35330-20012, 35330-20H00, 94850449



TOYOTA A130, A140E, A140L, A141E, A142E, A142L

1983-ON

Filter: 515820

Gasket: Cork: 03G820, Nitrile: 22G820

Kit: 7820

Pan Bolts: 15

OE: 35303-32010, 35330-32010, 94840966

A142L (Chevy Nova, Toyota Camry)



TOYOTA A140E, A140L, A141E, A142E, A142L (Camry SXV 10, Celica)

1991-ON

Filter: 515921

Gasket: Cork: 03G820, Nitrile: 22G820

Kit: 7921

Pan Bolts: 15

OE: 35330-32022, 94850882



TOYOTA A240E, A240L, A241E, A241L, A243E, A243L, A244E, A245E (Celica, Corolla, Geo Prizm), A246E, A247E

1985-ON

Filter: 515925

Gasket: Cork: 03G925, Nitrile: 22G925

Kit: 7925

Pan Bolts: 18

OE: 35330-12030, 94853372

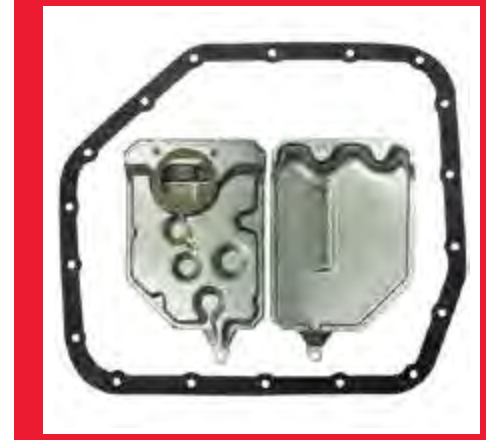

TOYOTA A240E, A240L, A241E, A241L, A243E, A243L, A244E, A245E (Corolla)

1985-1999

Filter: 515825

Gasket: Cork: 03G825, Nitrile: 22G825

Kit: 7825

Pan Bolts: 18

OE: 35330-12010, 35330-12011, 35330-12020, 94844936



TOYOTA A240E, A240L, A241E, A241L, A243E, A243L, A244E, A245E (Paseo 4.1, 1.5L)

1991-ON

Filter: 515926

Gasket: Cork: 03G825, Nitrile: 22G825

Kit: 7926

Pan Bolts: 18

OE: 94840882, 94849051, 94850882

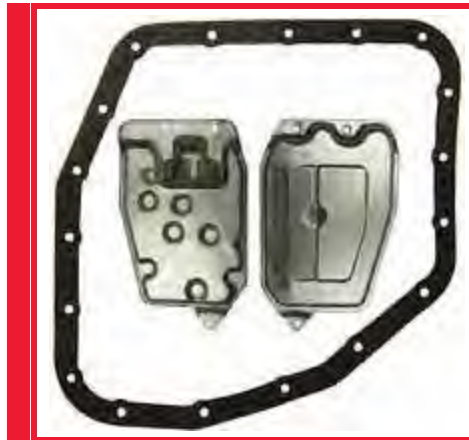

TOYOTA A246E

2003-ON

Filter: 515923

Gasket: Nitrile: 22G923

Kit: 7923

Pan Bolts: 18

OE: 35330-12040, 88972067



TOYOTA A30 (3 Speed) Front

1968-1978

Filter: 515801

Gasket: Nitrile: 22G801

Kit: 7804

Pan Bolts: 16

OE: 35303-30013



TOYOTA A30 (3 Speed) Rear

1968-1978

Filter: 515802

Gasket: Nitrile: 22G801

Kit: 7804

Pan Bolts: 16

OE: 35306-30011



TOYOTA A340E (2WD)

1985-ON

Filter: 515829

Gasket: Cork: 03G310, Nitrile: 22G310

Kit: 7829

Pan Bolts: 19

OE: 35330-30010, 35330-30011, 35330-33001



TOYOTA A340E (Jeep Eagle)

1987-ON

Filter: 515310

Gasket: Cork: 03G310, Nitrile: 22G310

Kit: 7310

Pan Bolts: 19

OE: 5083122AA, 83504032, 83504032AB, MR195988



TOYOTA A340E (R4AW3), A340F, A340H (V4AW3), A341E, A343E (Land Cruiser, Lexus), A343F (Land Cruiser, Lexus)

1995-ON

Filter: 515915

Gasket: Cork: 03G310, Nitrile: 22G310

Kit: 7915

Pan Bolts: 19

OE: 35330-60030, 8-97207143-0



TOYOTA A340E (R4AW3), A340F, A340H (V4AW3), A341E, A343E (Lexus GS300)

1996

Filter: 515913

Gasket: Cork: 03G310, Nitrile: 22G310

Kit: 7913

Pan Bolts: 19

OE: 35330-30040



TOYOTA A340E (R4AW3), A340F, A340H (V4AW3), A341E, A343E (Lexus GS300)

1993-1995

Filter: 515919

Gasket: Cork: 03G310, Nitrile: 22G310

Kit: 7919

Pan Bolts: 19

OE: 35330-30020



TOYOTA A340E (R4AW3), A340F, A340H (V4AW3), A341E, A343E (Lexus LS / SC400 V8)

1990-ON

Filter: 515828

Gasket: Cork: 03G310, Nitrile: 22G310

Kit: 7828

Pan Bolts: 19

OE: 35330-50010, 354192008, 3549200-8, 35492008



TOYOTA A340F (T100 P / U 8/97-ON, Tacoma P / U 9/96-99, 4Runner), A343F (Land Cruiser, Lexus)

1995-ON

Filter: 515928

Gasket: Cork: 03G310, Nitrile: 22G310

Kit: 7928

Pan Bolts: 19

OE: 35330-60020

Pickup, .75" Tube

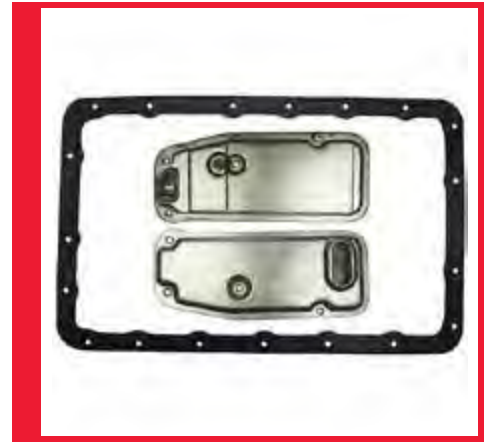

TOYOTA A340F (Toyota T100 P / U 94-8/97, Tacoma 95-9/96)

1994-1997

Filter: 515929

Gasket: Cork: 03G310, Nitrile: 22G310

Kit: 7929

Pan Bolts: 19

OE: 35330-22010



TOYOTA A340H (4WD)

1985-ON

Filter: 515827

Gasket: Cork: 03G310, Nitrile: 22G310

Kit: 7827

Pan Bolts: 19

OE: 35303-35010, 8-94479921-0, 8-94479921-1, MR166573



TOYOTA A343F (Land Cruiser, 4Runner)

1995-ON

Filter: 515918

Gasket: Cork: 03G310, Nitrile: 22G310

Kit: 7918

Pan Bolts: 19

OE: 35330-35020



TOYOTA A440F

1988-ON

Filter: 515832

Gasket: Cork: 03G830, Nitrile: 22G830

Kit: 7832

Pan Bolts: 20

OE: 35330-60011

.625" Thick



TOYOTA A440F

1985-1992

Filter: 515830

Gasket: Cork: 03G830, Nitrile: 22G830

Kit: 7830

Pan Bolts: 20

OE: 35303-60010, 35303-60011

2" Thick



TOYOTA A442F

1993-1995

Filter: 515927

Gasket: Cork: 03G830, Nitrile: 22G830

Kit: 7927

Pan Bolts: 20

OE: 35330-60010



TOYOTA A442F (Land Cruiser 100 Series - Non USA Only)

2003-ON

Filter: 515793

Gasket: Cork: 03G830, Nitrile: 22G830

Kit: 7793

Pan Bolts: 20

OE: 35330-60040



TOYOTA A540E, A540H, A541E

1993-ON

Filter: 515924

Gasket: Cork: 03G831, Nitrile: 22G831

Kit: 7924

Pan Bolts: 17

OE: 35330-33010, 35330-33030

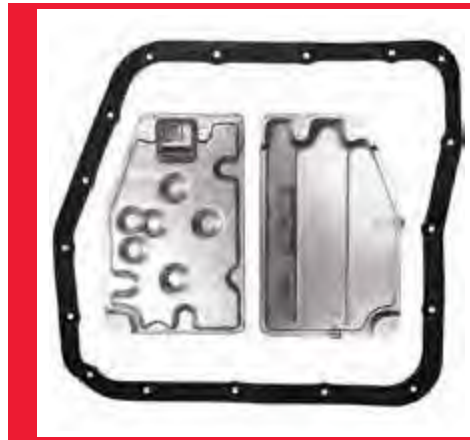

TOYOTA A540E, A540H, A541E (RAV4, Sienna)

1993-ON

Filter: 515831

Gasket: Cork: 03G831, Nitrile: 22G831

Kit: 7831

Pan Bolts: 17

OE: 35330-32030, 35330-32031



TOYOTA A55 (2WD)

1979-1986

Filter: 515821

Gasket: Cork: 03G821, Nitrile: 22G821

Kit: 7821

Pan Bolts: 17

OE: 35303-16010, 35303-16020, 35303-16H00

.25" Thick



TOYOTA A55 (4WD)

1982-1986

Filter: 515826

Gasket: Cork: 03G821, Nitrile: 22G821

Kit: 7826

Pan Bolts: 17

OE: 35303-16030

.625" Thick

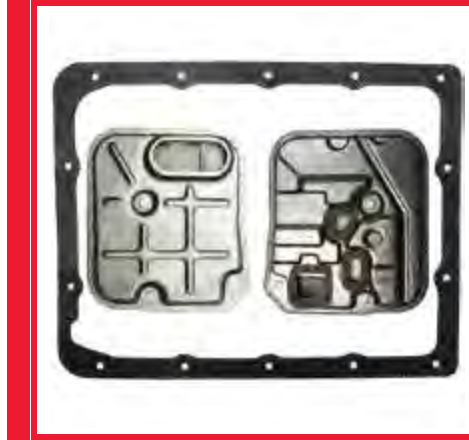

TOYOTA A650E (IS200)

2000-ON

Filter: 515907

Gasket: Cork: 03G800, Nitrile: 22G800

Kit: 7907

Pan Bolts: 14

OE: 35330-22032



**TOYOTA A650E (Lexus GS400/
GS430, IS300, IS400/IS430,
SC400/SC430)**

1997-ON

Filter: 515910

Gasket: Cork: 03G310, Nitrile: 22G310

Kit: 7910

Pan Bolts: 19

OE: 35330-30070



TOYOTA A750E, A750F

2003-ON

Filter: 515909

Gasket: Nitrile: 22G909

Kit: 7909

Pan Bolts: 20

OE: 35330-60050



TOYOTA A960E

2006-ON

Filter: 515798

Gasket: NA

Kit: No Kit

Pan Bolts: NA

OE: 35330-30090



**TOYOTA MX17 (A210) (Chevy
Sprint)**

1985-ON

Filter: 515819

Gasket: Cork: 03G819, Nitrile: 22G819

Kit: 7819

Pan Bolts: 15

OE: 26570-82300, 35303-87703-000,
96053975

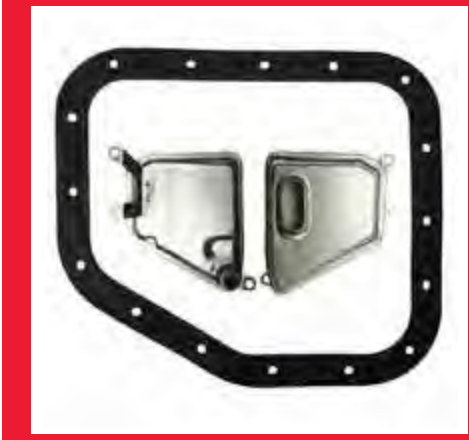

TOYOTA MX17 (A210) (Daihatsu)

1988-1991

Filter: 515891

Gasket: Nitrile: 22G891

Kit: 7891

Pan Bolts: 16

OE: 35303-87200

Pan



TOYOTA U140E

1999-ON

Filter: 515916

Gasket: Cork: 03G916, Nitrile: 22G916

Kit: 7916

Pan Bolts: 18

OE: 35330-06010, 35330-0W010, 35330-21020



TOYOTA U151

2004-ON

Filter: 515911

Gasket: Cork: 03G916, Nitrile: 22G916

Kit: 7911

Pan Bolts: 18

OE: 35330-08010



TOYOTA U340E (Old Design)

1999-ON

Filter: 515912

Gasket: Cork: 03G912

Kit: 7912

Pan Bolts: 14

OE: 35330-20020



TOYOTA U341E (Lexus)

1999-ON

Filter: 515917

Gasket: Nitrile: 22G917

Kit: 7917

Pan Bolts: 19

OE: 35330-0W020, 35330-0W021, 35330-20020, 88971813



TOYOTA / DAIHATSU A4LB1 (Serion)

1994-ON

Filter: 515897

Gasket: NA

Kit: No Kit

Pan Bolts: NA

OE: 35303-97201



TOYOTA / DAIHATSU A4LB1, U540E (Terios)

1994-2009

Filter: 515896

Gasket: NA

Kit: No Kit

Pan Bolts: NA

OE: 35303-97501



TOYOTA / LEXUS A760, AB60E, AB60F

11/2007-ON

Filter: 515794

Gasket: Nitrile: 22G909

Kit: 7794

Pan Bolts: 20

OE: 35330-60060

Long Inlet



TOYOTA / LEXUS A761E (Toyota, Lexus)

2003-ON

Filter: 515799

Gasket: Nitrile: 22G909

Kit: 7799

Pan Bolts: 20

OE: 35330-50020

Felt Media



TOYOTA / LEXUS U660E, U660F

2007-ON

Filter: 515795

Gasket: Nitrile: 22G795

Kit: 7795

Pan Bolts: 18

OE: 35330-33050



TOYOTA / LEXUS U760E, TM-60LS

2009-ON

Filter: 515796

Gasket: Cork: 03G796, Reusable w/metal torque limiters: 14G796, Nitrile: 22G796

Kit: 7796

Pan Bolts: 19

OE: 35330-73010



TOYOTA / MITSUBISHI A40, A41, AW55, BW55

1974-1981

Filter: 515800

Gasket: Cork: 03G800, Nitrile: 22G800

Kit: 7800

Pan Bolts: 14

OE: 35303-22020, 35303-22021, 35303-22022, 53446-80011, 5344680011



**TOYOTA / MITSUBISHI A40D,
A41D**

1978-ON

Filter: 515815

Gasket: Cork: 03G800, Nitrile: 22G800

Kit: 7815

Pan Bolts: 14

OE: 35303-30030, 35303-30031



**TOYOTA / MITSUBISHI A42D,
A43D, AW70, AW71**

1981-ON

Filter: 515811

Gasket: Cork: 03G800, Nitrile: 22G800

Kit: 7811

Pan Bolts: 14

OE: 1239829-3, 35303-30050,
8-94244562-0, 8-94244562-2, MD609041



**TOYOTA / MITSUBISHI A42DL,
A43DL, A44DL, A45DL**

1982-ON

Filter: 515810

Gasket: Cork: 03G800, Nitrile: 22G800

Kit: 7810

Pan Bolts: 14

OE: 1340021-3, 35303-14010,
8-94405362-0, 8-94405362-2, MD609189



TOYOTA / MITSUBISHI A43D

2002-2004

Filter: 515908

Gasket: Cork: 03G800, Nitrile: 22G800

Kit: 7908

Pan Bolts: 14

OE: 35303-35020

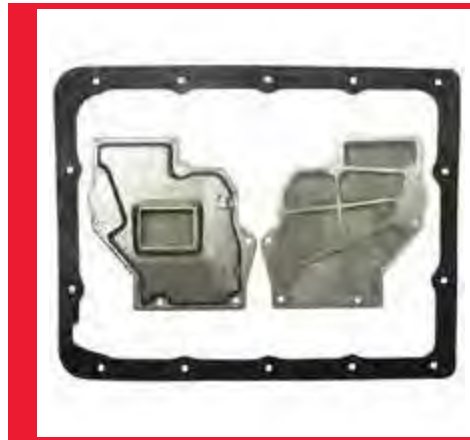

**TOYOTA / MITSUBISHI A43DE (4
Speed), A46DE, A46DF**

1990-ON

Filter: 515822

Gasket: Cork: 03G800, Nitrile: 22G800

Kit: 7822

Pan Bolts: 14

OE: 0K0-151-9815, 26582-57B00,
35303-30060, 91172478, BV8B-19-815,
OK01519815



**VOLKSWAGEN / AUDI 010, 087,
089, 090**

1975-1977

Filter: 515410

Gasket: Molded Rubber: 04G420

Kit: 7410

Pan Bolts: NA

OE: 010-325-421

Rectangular



VOLKSWAGEN / AUDI 010, 087, 089, 090

1977-1993

Filter: 515420

Gasket: Molded Rubber: 04G420

Kit: 7420

Pan Bolts: NA

OE: 010-325-421A

Round



VOLKSWAGEN / AUDI 01J (CVT), 0AW (CVT)

2002-ON

Filter: 515723

Gasket: NA

Kit: No Kit, Disassembly

Pan Bolts: NA

OE: 01J-301-519L



VOLKSWAGEN / AUDI 09E
1969-1976

Filter: 515417

Gasket: Cork: 03G417, Nitrile: 22G417

Kit: 7417

Pan Bolts: 13

OE: 003-325-421



VOLKSWAGEN / AUDI 09K
(European Version)

2004-ON

Filter: 515724

Gasket: NA

Kit: No Kit

Pan Bolts: 7

OE: 09K-325-429



VOLKSWAGEN / AUDI 09M

2003-ON

Filter: 515432

Gasket: NA

Kit: No Kit

Pan Bolts: 9

OE: 09M-325-429



VOLKSWAGEN / AUDI 0B5
(DL501) DCT 7 SPEED DSG

2008-ON

Filter: 515996

Gasket: Nitrile: 22G996

Kit: 7996

Pan Bolts: 15

OE: 0B5-325-429E



VOLKSWAGEN / AUDI AG4

1990-1995

Filter: 515425

Gasket: Molder Rubber: 04G425

Kit: 7425

Pan Bolts: NA

OE: 095-325-429C, 095-325-429D



VOLKSWAGEN / AUDI AG4

1996-ON

Filter: 515427

Gasket: Molder Rubber: 04G425

Kit: 7427

Pan Bolts: 4

OE: 01M-325-429



VOLKSWAGEN / AUDI AL450 (VW Amarok)

2012-2014

Filter: 515371

Gasket: NA

Kit: No Kit

Pan Bolts: 13

OE: 0501-218-004



VOLKSWAGEN / AUDI DSG / 02E DSG (6 Speed)

2003-ON

Filter: 515424

Gasket: NA

Kit: No Kit

Pan Bolts: NA

OE: 02E-305-051B, 02E-305-051C



VOLKSWAGEN / AUDI JF404E

1999-ON

Filter: 515430

Gasket: NA

Kit: No Kit, Disassembly

Pan Bolts: NA

OE: 001-325-429



VOLKSWAGEN / AUDI JF404E

1999-ON

Filter: 515879

Gasket: Nitrile: 22G879

Kit: 7879

Pan Bolts: 20

OE: 001-325-429A



**VOLKSWAGEN / AUDI TF60SN,
09G**

2004-ON

Filter: 515422

Gasket: Molded Rubber: 04G423

Kit: 7422

Pan Bolts: 8

OE: 09G-325-429-A

With wide raised intake

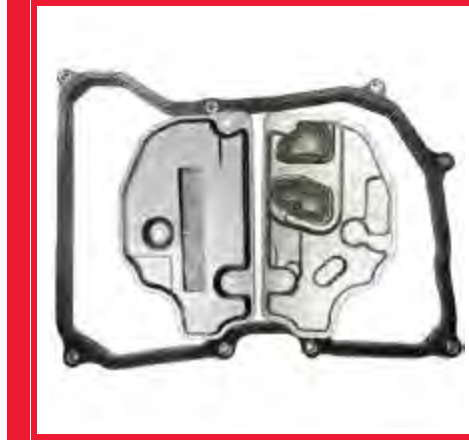

**VOLKSWAGEN / AUDI TF60SN,
09G (VW Golf L5 2.5L)**

2007-ON

Filter: 515423

Gasket: Molded Rubber: 04G423

Kit: 7423

Pan Bolts: 8

OE: 09G-325-429

With narrow flush intake

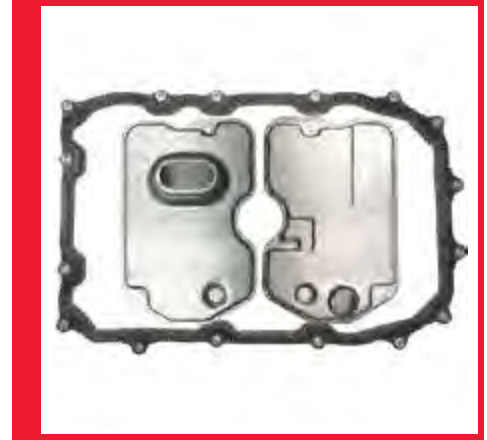

**VOLKSWAGEN / AUDI TR60SN,
09D**

2002-ON

Filter: 515428

Gasket: Molded Rubber: 04G428

Kit: 7428

Pan Bolts: 16

OE: 09D-325-429, 09D-325-435



VOLKSWAGEN / AUDI TR80SD

2010-ON

Filter: 515433

Gasket: Molded Rubber: 04G433

Kit: 7433

Pan Bolts: 11

OE: 0C8-325-435

Inlet Height 1.294"



ZF 3HP22 (BMW)

1976-1984

Filter: 515816

Gasket: Molded Rubber: 04G816

Kit: 7816

Pan Bolts: NA

OE: 1024-223-002, 24341-209-747



ZF 4HP18 (Transverse)

1986-ON

Filter: 515834

Gasket: Molded Rubber: 04G833

Kit: 7834

Pan Bolts: NA

OE: 1501-311-497, 7575525, 7599525



ZF 4HP18, 4HP14

1986-ON

Filter: 515833

Gasket: Molded Rubber: 04G833

Kit: 7833

Pan Bolts: NA

OE: 1036-226-013, 4728878, 83504685

In-line



ZF 4HP18, 4HP18FLE (Audi Only)

1991-ON

Filter: 515426

Gasket: Molded Rubber: 04G833

Kit: 7426

Pan Bolts: NA

OE: 01F-325-433, 01M-325-429, 0501-

004-608, 0501-004-609



ZF 4HP20

1998-ON

Filter: 515975

Gasket: Molded Rubber: 04G975

Kit: 7975

Pan Bolts: NA

OE: 0501-315-183, 1019-222-019

Long Tube



ZF 4HP20 (Peugeot), 4HP16 (04-ON)

1995-1999

Filter: 515977

Gasket: Molded Rubber: 04G975

Kit: 7977

Pan Bolts: NA

OE: 0501-315-184, 26440-86Z00,

93742042

Short Tube



ZF 4HP22

1993-1995

Filter: 515982

Gasket: Molded Rubber: 04G824

Kit: 7982

Pan Bolts: NA

OE: 943-307-011-01, 943-307-011-02



ZF 4HP22 (BMW), 4HP-24

1987-ON

Filter: 515835

Gasket: Molded Rubber: 04G424

Kit: 7835

Pan Bolts: NA

OE: 1043-226-034, 24311-218-204,

24311-218-571, JLM2128

1" Pickup Tube

**ZF 4HP22 (Except Rover)****1982-ON**

Filter: 515824

Gasket: Molded Rubber: 04G824

Kit: 7824

Pan Bolts: NA

OE: 1043-226-036, 24311-218-550,
24341-215-544, 24341-215-550, E4LY-
7A098-A, JLM2122, JLM664

No Pickup Tube

**ZF 4HP22 (Rover), 4HP-24 (Rover) (87-ON)****1985-1994**

Filter: 515979

Gasket: Molded Rubber: 04G824

Kit: 7979

Pan Bolts: NA

OE: 1043-226-037, RTC4653

.625" Pickup Tube

**ZF 4HP24A****1989-1994**

Filter: 515974

Gasket: NA

Kit: 7974

Pan Bolts: NA

OE: 1043-226-035

2.5" Pickup Tube

**ZF 5HP18****1991-1995**

Filter: 515984

Gasket: Molded Rubber: 04G984

Kit: 7984

Pan Bolts: NA

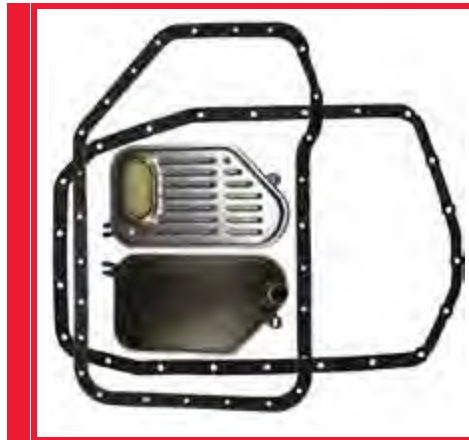
OE: 0501-005-185, 24341-219-631,
24341-422-513**ZF 5HP19, 5HP19FL, 5HP19FLA****1997-2004**

Filter: 515971

Gasket: Nitrile: 22G971 (22 holes), 22G981
(27 holes)

Kit: 7971

Pan Bolts: 27, 22

OE: 0501-210-388, 24341-423-376

**ZF 5HP24, 5HP24A (2WD)****1995-2006**

Filter: 515983

Gasket: Nitrile: 22G983

Kit: 7983

Pan Bolts: 22

OE: 01L-325-429, 0501-004-925, 24341-
422-673, JLM20216

Slotted Intake



ZF 5HP24, 5HP24A (4WD)

1995-2006

Filter: 515973

Gasket: Nitrile: 22G973

Kit: 7973

Pan Bolts: 26

OE: 01L-325-429B, 0501-006-460

.75" Tube



ZF 5HP24, 5HP24A (4WD)

1995-2006

Filter: 515976

Gasket: Nitrile: 22G983

Kit: 7976

Pan Bolts: 22

OE: 01L-325-429-A, 01L-325-429A

1" Tube



ZF 5HP30

1992-2003

Filter: 515980

Gasket: Nitrile: 22G980

Kit: 7980

Pan Bolts: 23

OE: 0501-005-184, 24341-421-200,

24341-422-229, 24341-422-419



ZF 6HP19, 6HP19A, 6HP19X

2001-2011

Filter: 515442

Gasket: NA

Kit: No Kit

Pan Bolts: 13

OE: 0501-212-401, 09L-325-429

Overall Height 5.56"; Outlet Tube Height 4.80" / 122mm



ZF 6HP19, 6HP19A, 6HP19X

2004-ON

Filter: 515987B

Gasket: Includes pan gasket, drain plug and magnets

Kit: No Kit

Pan Bolts: 24

OE: 24117-536-387, 24117-571-217

(Revision of 515987 With Replaceable Filter Includes Pan Gasket, Drain Plug And Magnets)



ZF 6HP26, 6HP26A, 6HP26X

2002-2009

Filter: 515970B

Gasket: Includes pan gasket, drain plug and magnets

Kit: No Kit

Pan Bolts: 21

OE: 21117-522-923, 24117-522-923, 24117-571-227, C2C-6715

(Revision of 515970 With Replaceable Filter Includes Pan Gasket, Drain Plug And Magnets)



**ZF 6HP26, 6HP26A, 6HP26X
(2WD)**

2007-2009

Filter: 515263

Gasket: Cork: 03G263, Reusable w/metal
torque limiters: 14G263, Nitrile: 22G263

Kit: 7263

Pan Bolts: 21

OE: NA

1.5" Pickup Tube



**ZF 6HP26, 6HP26A, 6HP26X
(2WD)**

2002-2006

Filter: 515264

Gasket: Cork: 03G263, Reusable w/metal
torque limiters: 14G263, Nitrile: 22G263

Kit: 7264

Pan Bolts: 21

OE: 6L2Z-7A098-AA

Flat Bottom, 3.003" Neck



**ZF 6HP26, 6HP26A, 6HP26X
(4WD)**

2004-2009

Filter: 515421

Gasket: Nitrile: 22G421

Kit: 7421

Pan Bolts: 24

OE: 0501-212-974, 09E-325-429

3.534" Neck



ZF 8HP45

2011-ON

Filter: 515768

Gasket: NA

Kit: No Kit

Pan Bolts: 13

OE: 0501-218-048, 68142478AB

Shallow Pan With Replaceable Filter Includes Pan
Gasket, Drain Plug And Magnets



**ZF GACVT16Z (Mini Cooper 1.6L,
Mini One R50, Austin CVT)**

2002-2009

Filter: 515994

Gasket: Nitrile: 22G994

Kit: 7994

Pan Bolts: NA

OE: 24117-518-741



ZF ZF5HP19FLA (Audi)

1995-2004

Filter: 515981

Gasket: Nitrile: 22G981

Kit: 7981

Pan Bolts: 27

OE: 01V-325-421, 01V-325-429, 0501-209-
251, 722-277-009-05, 986-307-001-01



ZF CHRYSLER 8HP45X, 8HP55A, 8HP55AH, 8HP70XH, 8HP90 (VW Amarok)

2012-2014

Filter: 515371

Gasket: NA

Kit: No Kit

Pan Bolts: 13

OE: 0501-218-004

OE Transmission Filter



ZF CHRYSLER 8HP55 / OBK, 8HP70, 8HP50Z (4WD/AWD)

2010-ON

Filter: 515370

Gasket: Reusable w/metal torque limiters: 14G370

Kit: 7370

Pan Bolts: 12

OE: PART OF OBK398009



ZF CHRYSLER 8HP70

2010-ON

Filter: 515769

Gasket: Includes pan gasket, drain plug and magnets

Kit: No Kit

Pan Bolts: 13

OE: 52854834AA

(Deep Pan With Replaceable Filter Includes Pan Gasket, Drain Plug And Magnets)



ZF CHRYSLER 8HP70/8HP50Z

2011-ON

Filter: 515770

Gasket: Includes pan gasket, drain plug and magnets

Kit: No Kit

Pan Bolts: 13

OE: 0501-220-614

OE Transmission Filter (Shallow Pan/Filter Combo, Gasket And Drain Plug Included)



ZF CHRYSLER 9HP48, 948TE

2013-ON

Filter: 515625

Gasket: NA

Kit: No Kit, Disassembly

Pan Bolts: NA

OE: 0501-217-695



ZF GETRAG GS7D36SG

2007-ON

Filter: 515225

Gasket: NA

Kit: No Kit

Pan Bolts: NA

OE: 28-10-7-842-828



Transmission Cooler Line size 1/2" Magnetic In-Line Filter with Bypass

NA

Filter: 515553

Gasket: NA

Kit: 7553

Pan Bolts: NA

OE: 2W4Z-7B155-BA, 2W4Z-7B155-E



Transmission Cooler Line size 3/8" Magnetic In-Line Filter with Bypass

NA

Filter: 515554

Gasket: NA

Kit: 7554

Pan Bolts: NA

OE: XC3Z-7B155-BA



Transmission Cooler Line size 5/16" Magnetic In-Line Filter with Bypass

NA

Filter: 515555

Gasket: NA

Kit: 7555

Pan Bolts: NA

OE: 3610 MAG



Transmission Pan Chrysler 42RLE

2006-2013

Filter: RP42RLE

Gasket: NA

Kit: No Kit

Pan Bolts: 13

OE: 52852912AC

Transmission Pan - Coated Steel, No Drain Plug



Transmission Pan Ford C6 (2WD)

1966-UP

Filter: RPC6

Gasket: NA

Kit: No Kit

Pan Bolts: 17

OE: F5TZ-7A194-D

Transmission Pan - Uncoated Steel, With Drain Plug (2WD)

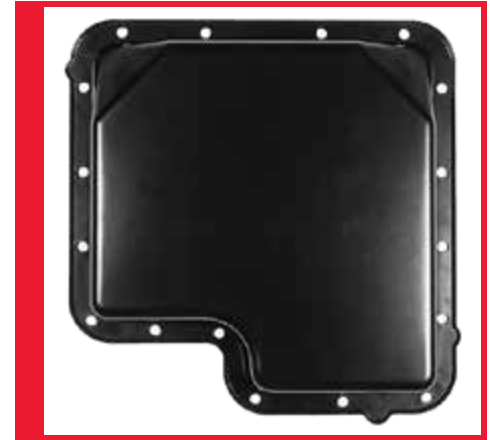

Transmission Pan Ford C6 (2WD)

1966-UP

Filter: RPC6B

Gasket: NA

Kit: No Kit

Pan Bolts: 17

OE: F5TZ-7A194-D

Transmission Pan - Coated Steel, No Drain Plug (2WD)



Transmission Pan Ford E40D, 4R100

1996-2005

Filter: RPE40D

Gasket: NA

Kit: No Kit

Pan Bolts: 20

OE: F81Z-7A194-BA

Transmission Pan - Coated Steel, Deep Pan With Drain Plug



Transmission Pan GM 4T45E, 4T40

1995-2011

Filter: RP4T45E

Gasket: NA

Kit: No Kit

Pan Bolts: 14

OE: 8685184

Transmission Pan - Coated Steel, No Drain Plug



Transmission Pan VW 09G / TF60SN, 09K, 09M

2003-0N

Filter: RPO9G

Gasket: NA

Kit: No Kit

Pan Bolts: 8

OE: 09G-321-361A

Transmission Pan - Coated Steel, With Drain Plug

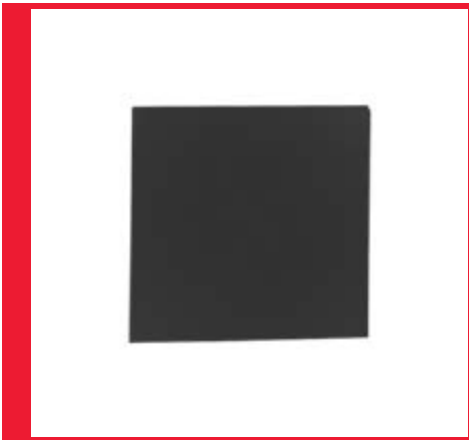

Transmission Pan Magnet 1.33" X 1.33" (33.75mm), Metallic, Square

NA

Filter: RM900075

Gasket: NA

Kit: No Kit

Pan Bolts: NA

OE: NA



Drain Pan Funnel 23" X 23", Plastic

NA

Filter: 624999

Gasket: NA

Kit: No Kit

Pan Bolts: NA

OE: NA

Make	Model	Year	Kit	Filter	Gasket	Pan Bolts	OE Numbers	Notes
AISIN WARNER	AW30-40 (Jeep)	1992-2001	7310	515310	Cork: 03G310, Nitrile: 22G310	19	5083122AA, 83504032, 83504032AB, MR195988	
AISIN WARNER	AW30-40 (Toyota Supra, SC300/400, LS400, Volvo)	1992-ON	7828	515828	Cork: 03G310, Nitrile: 22G310	19	35330-50010, 354192008, 3549200-8, 35492008	
AISIN WARNER	AW450-43LE, ISUZU RNJ	1998-ON	7889	515889	Cork: 03G830, Nitrile: 22G830	20	8-97202067-0, 97202067	
AISIN WARNER	AW50-40LE	1989-1998	No Kit, Disassembly	515990	NA	NA	8651909, 90348726	European
AISIN WARNER	AW50-40LM, AW50-41LE, AW50-42LE	1999-2007	No Kit, Disassembly	515888	NA	NA	30681088, 5164553, 90541934, 9480049-0	
AISIN WARNER	AW60-40, AW60-40SN, AW60-41SN, AW60-42LE (AF-13)	1995-2004	7890	515890	Nitrile: 22G890	15	26445-60G10	
AISIN WARNER	AW81-40LE (U441E)	2004-ON	7540	515540	Nitrile: 22G540	18	35330-52010, 93741509	
AISIN WARNER	GA6F21WA (Mini Cooper)	2007-ON	7997	515997	NA	8	24-34-7-566-358	With 18mm Pickup Tube
AISIN WARNER	GA6F21WA (Mini Cooper)	2005-ON	7998	515998	NA	8	24-34-7-551-087	With 24mm Pickup Tube
AISIN WARNER	TF80SC (AF40, AF40-6), TF81SC (AF21, AWF21), AW6AEL	2005-ON	No Kit, Disassembly	515200	NA	NA	60-27-0F099-0080	
AISIN WARNER / NISSAN	AW55-50SN, AW55-51SN, 2003-2007 AF23, AF33, RE5F22A (Nissan, Infiniti)	2003-2007	No Kit, Disassembly	515886	NA	NA	31728-8Y000, 31728-8Y010	With Rib
AISIN WARNER / NISSAN	AW55-50SN, AW55-51SN, 1999-2007 AF23, AF33, RE5F22A (Saab, Saturn, Volvo, Opel)	1999-2007	No Kit, Disassembly	515887	NA	NA	24220578, 93177682	
AISIN WARNER / NISSAN	AW55-50SN, AW55-51SN, 1999-2007 AF33-5 (Chevy, Pontiac)	1999-2007	No Kit, Disassembly	515713	NA	NA	24240239	
AISIN WARNER / TOYOTA	TL80SN, AA80E	2007-ON	No Kit	515792	NA	9	35330-50030	
ALLISON	AT540, AT543, AT545	1970-ON	7532	515532	Cork: 03G532, Nitrile: 22G532	21	12337210, 29506392D, 29540976, 6438326, 6884270	Stainless Screen
ALLISON	AT540, AT543, AT545	1970-ON	7732	515732	Cork: 03G532, Nitrile: 22G532	21	1878301862, 29503617, 29506392, 94058636	Brass Screen
ALLISON	HD SERIES HD4560, B500, MD SERIES 500/P/R/PR	1995-ON	7106	515106	w/O-ring Kit: SK106	NA	29526899, 29540493, 29545776	4" High Canister Style For 2" Sump
ALLISON	HD SERIES HD4560, B500, MD SERIES 500/P/R/PR	1995-ON	7107	515107	w/O-ring Kit: SK106	NA	29540494, 29545779, 29545780	6" High Canister Style For 4" Sump
ALLISON	HT740, HT747, HT750, HT754, V730	1972-ON	7102	515102	Cork: 03G105, Nitrile: 22G105	23	6839945	With 6" Tube
ALLISON	HT740, HT747, HT750, HT754, V730	1972-1975	7103	515103	Cork: 03G105, Nitrile: 22G105	23	23045042, 29530562 (KIT)	With 4.5" Tube
ALLISON	HT740, HT747, HT750, HT754, V730	1975-ON	7104	515104	Cork: 03G532, Nitrile: 22G532	21	29538491	With 5" Tube, 7" Pan
ALLISON	HT740, HT747, HT750, HT754, V730	1972-ON	7105	515105	Cork: 03G105, Nitrile: 22G105	23	23013625, 29505563	With 7" Tube
ALLISON	LT1000, LT2000, LT2400 SERIES	1999-ON	7108	515108	NA	NA	29531007, 29537268, 29537269, 29539579, 97730071	External Spin On
ALLISON	LT1000, LT2000, LT2400 SERIES	1999-2009	7482	515482	Reusable w/ metal torque limiters: 14G482, Nitrile: 22G482	12	29537514, 29537965	Shallow Pan

Make	Model	Year	Kit	Filter	Gasket	Pan Bolts	OE Numbers	Notes
ALLISON	LT1000, LT2000, LT2400 SERIES	1999-2009	7483	515483	Reusable w/ metal torque limiters: 14G482, Nitrile: 22G482	12	29537617, 29537966	Deep Pan
ALLISON	LT1000, LT2000, LT2400 SERIES	2010-ON	7484	515484	Reusable w/ metal torque limiters: 14G482, Nitrile: 22G482	12	29542833	Shallow Pan
ALLISON	LT1000, LT2000, LT2400 SERIES	2010-ON	7485	515485	Reusable w/ metal torque limiters: 14G482, Nitrile: 22G482	12	29542824	Sump Filter (Deep Pan)
ALLISON	MT640, MT643, MT644, MT650, MT653, MT654	1972-ON	7101	515101	Cork: 03G532, Nitrile: 22G532	21	23012457, 23019201, 29502302, 29527373, 29538474, 29538489, 29538490, 29538492, 5574991, 6882787, 6883044, 6885287	Late Without Tube
BORG WARNER	T35, T37, T44, T65, T66	1963-ON	7500	515500	Nitrile: 22G504	15	3170356, 3179973, DORY-7A098-A	Front Shroud - 199 Engine 1968-70
BORG WARNER	T35, T37, T44, T65, T66	1969-ON	7501	515501	Nitrile: 22G504	15	3188896, AAU7085, MD950886	Front Shroud Except 199 Engine 1968-70
BORG WARNER	T35, T37, T44, T65, T66	1962-ON	7504	515504	Nitrile: 22G504	15	3164950, 3170356, 3179973	AMC Flashomatic
BORG WARNER	T35, T37, T44, T65, T66	1981-1993	No Kit	515502	Nitrile: 22G504	12	4277455, DORY-7A098-B	Filter - Transmission Filter (Saab 4 Speed)
BORG WARNER / BTR	BW-85, 85, 91, 95LE, 74, 93, 97LE	1989-ON	No Kit	515505	NA	NA	ED78000KTF, TGM-10011	Sump Filter (Pan)
CHRYSLER	42RE, 44RE, 46RE, 47RE, 48RE	1997-2004	7607	515607	Cork: 03G413, 03G613, 63G613 Nitrile: 22G413, 22G613	14, 14	52118789	
CHRYSLER	42RLE	2003-ON	7608	515608	Cork: 03G608, Nitrile: 22G608	14	52852913AA, 52852913AB	4 Speed
CHRYSLER	45RFE, 545RFE	1999-ON	No Kit	514129	NA	NA	4799086	Bleed Orifice Filter
CHRYSLER	45RFE, 545RFE (2WD), 68RFE (2WD)(07-ON)	1999-2009	7494	515494	Cork: 03G492, Nitrile: 22G492	15	04800029AA, 05015267AC	Sump Filter With Lipseal And Valve
CHRYSLER	45RFE, 545RFE, 65RFE, 66RFE (2WD), 68RFE (4WD)	See Notes	7492	515492	Cork: 03G492, Nitrile: 22G492	15	05013470AA, 05013470AB, 05013470AC, 05013470AD, 05013470AE, 4799507	Sump Filter With Lipseal And Valve, 545RFE (2WD) 10-ON (4WD) 99-ON, 66RFE (2WD) 12-ON, 68RFE (4WD) 07-ON
CHRYSLER	45RFE, 545RFE, 65RFE, 66RFE, 68RFE (2WD, 4WD)	1999-ON	7490	515490	Cork: 03G492, Nitrile: 22G492	NA	04799662AB, 05179267AC, 4799662, 4799662A, 4799662AB, 5179267AC	Spin On
CHRYSLER	62TE	2007-ON	7610	515610	Nitrile: 22G610	12	68018555AA	
CHRYSLER	6F24	2012-ON	No Kit, Disassembly	515624	NA	NA	68192984AA	With Green Rectangle Seal
CHRYSLER	722.6 (96-ON), NAG1 (W5A380) (04-ON)	1996-ON	7870	515870	04G870	6	140-272-0095, 140-277-0095, 52108325AA, BU01-19-815, JLM20470	

Make	Model	Year	Kit	Filter	Gasket	Pan Bolts	OE Numbers	Notes
CHRYSLER	845RE	2013-ON	No Kit	515769	Comes with filter	13	52854834AA	Deep Pan With Replaceable Filter Includes Pan Gasket, Drain Plug And Magnets
CHRYSLER	A404, 30TH, 31TH, A413, A470, A670	1978-ON	No Kit	514113	NA	NA	5205839	Governor Filter
CHRYSLER	A404, 30TH, 31TH, A413, A470, A670 (Early)	1978-1982	7411	515411	Cork: 03G411, Nitrile: 22G411	14	4207219, 5212145	
CHRYSLER	A404, 30TH, 31TH, A413, A470, A670 (Late)	1983-ON	7470	515470	Cork: 03G411, Nitrile: 22G411	14	4269649, 4289249	
CHRYSLER	A500 / 44RE, A500 / 40RH, 42RH, 44RH, A500SE / 42RE, A904 / A500, A518 / 46RH, A518ES / 46RE, A618 / 47RH, A618ES / 47RE, 48RE, TF6, A904 / 30RH, A998 / 31RH, A999 / 32RH, TF8, A727 / 36RH / 37RH	1967-2003	7612, 7613, 7614	515613	Cork: 03G613, 03G712, Nitrile: 22G613	14	3515996, 8123042, J8123042, M3515996	All Large, Felt 1 Hole
CHRYSLER	A604 (4 Speed)	1989-ON	7604	515604	Cork: 03G604, 63G604, Nitrile: 22G604	14	04864505AB, 4504048, 4864505, M04504048, M04864505, M04504048	
CHRYSLER	A604, 40TE, 41TE, 41AE	1989-ON	No Kit	514105	NA	NA	4446629	Orifice Filter
CHRYSLER	A604, 40TE, 41TE, 41AE	1989-ON	No Kit	514107	NA	NA	4531903	Orifice Filter
CHRYSLER	A604, 40TE, 41TE, 41AE	1999-ON	No Kit	514130	NA	NA	50008024AA	Solenoid Block
CHRYSLER	A604, 40TE, 41TE, 41AE, 42RLE	1989-ON	No Kit	514103	NA	NA	3738313, 3878313	Pump, Valve Body Filter
CHRYSLER	A606, 42LE	1993-ON	No Kit	514109	NA	NA	4539787	A606, 42LE Spacer Plate
CHRYSLER	A606, 42LE (4 Speed)	1993-ON	7606	515606	Cork: 03G606, Nitrile: 22G606	13	4626449, 4796730, 4796730AB	
CHRYSLER	AS68RC	2007-ON	7617	515617	Nitrile: 22G617	18	68019688AA	Sump Filter
CHRYSLER / ISUZU	AS68RC (2WD)	2007-ON	7618	515618	Nitrile: 22G617	18	8-98079401-0	Sump Filter (2WD Shallow Pan) (Isuzu)
CHRYSLER	AS69RC	2013-ON	7619	515619	Nitrile: 22G619	20	68224232AA	(6 Speed)
CHRYSLER	TF6, A904 / 30RH, A998 / 31RH, A999 / 32RH, TF8, A727 / 36RH / 37RH	1960-2003	No Kit	514127	NA	NA	3743519	TF6 Governor Filter
CHRYSLER	TF6, A904 / 30RH, A998 / 31RH, A999 / 32RH, TF8, A727 / 36RH / 37RH	1966-2003	7714	515714	Cork: 03G613, 03G712, Nitrile: 22G613, 22G712	14, 14	3515996, 8123042	All Large, Brass, 1 Hole
CHRYSLER	TF6, TF8, A727 / 36RH / 37RH	1960-1967	7412	515413	Cork: 03G413, Nitrile: 22G413	14	3621456, 8121065, 8122610	Small, Felt, 2 Holes
CHRYSLER	TF6, TF8, A727 / 36RH / 37RH	1960-1967	7514	515514	Cork: 03G413, Nitrile: 22G413, Nitrile: 22G613	14, 14	3410253	Small, Brass, 2 Holes
FORD	5R110W TorqShift	2008-ON	7196	515196	Cork: 03G042, Nitrile: 22G042	20	8C3Z-7A098-D	Internal Sump Filter
FORD	5R110W TorqShift	2008	No Kit	515197	NA	NA	7C3Z-7B155-B	External Remote Mount Cooler Line Filter
FORD	5R110W TorqShift	2003-2007	No Kit	515574	NA	NA	3C3Z-7B155-BA	External bypass, Element

Make	Model	Year	Kit	Filter	Gasket	Pan Bolts	OE Numbers	Notes
FORD	5R110W TorqShift	2003-ON	7577	515577	Cork: 03G042, Nitrile: 22G042	20	3C3Z-7A098-AA	Internal
FORD	5R55N, 5R55S	2003-2005	7575	515575	Cork: 03G576, 63G576, Nitrile: 22G576	16	3W4Z-7A098-AA	Short Tube
FORD	5R55N, 5R55S (Car Only)	1999-2002	7578	515578	Cork: 03G578, Reusable w/ metal torque limiters: 14G578, Nitrile: 22G578	16	XR85498, XW4Z-7A098-BA, XW4Z-7A098-BB	All Plastic, Short Tube
FORD	5R55W	2002-ON	7576	515576	Cork: 03G576, 63G576, Nitrile: 22G576	16	1L2Z-7A098-AC, IL2Z- 7A098-AB	Long Tube
FORD	6F35	2009-2012	No Kit, Disassembly	515265	NA	NA	9L8Z-7A098-A, 9L8Z- 7A098-B, 9L8Z-7A098-C	
FORD	6F35	2012-ON	No Kit, Disassembly	515267	NA	NA	BB5Z-7A098-B	Inlet Height .562"
FORD	6R140	2011-ON	7198	515198	Reusable w/ metal torque limiters: 14G198, Nitrile: 22G198	19	BC3Z-7A098-B	
FORD	6R60, 6R75	2006-2007	7264	515264	Cork: 03G263, OE-Style Aluminum + Rubber: 14G263, Nitrile: 22G263	21	6L2Z-7A098-AA	With Flat Bottom, 3.003" Neck
FORD	6R60, 6R75, 6R80	2007-2010	7263	515263	Cork: 03G263, OE-Style Aluminum + Rubber: 14G263, Nitrile: 22G263	21	7L1Z-7A098-A	With 1.5" Pickup Tube
FORD	6R80, 6R100	2011-2018	7273	515273	Cork: 03G263, OE-Style Aluminum + Rubber: 14G263, Nitrile: 22G263	21	BL3Z-7A098-A	Shallow Pan
FORD	6R80 (F150 2.7L, 3.3L, 3.5L)	2015-2018	No Kit	515271	Nitrile: 14G263, 22G263	21	FL3Z-7A098-A, FL3Z- 7A098-B	
FORD	6R80 (Ford Transit)	2015-ON	7272	515272	Cork: 03G263, OE-Style Aluminum + Rubber: 14G263, Nitrile: 22G263	21	CK4Z-7A098-A	With Long Metal Inlet
FORD	10R80	2017-ON	No Kit	515280	NA	18	HL3Z-7A098-A	Round Inlet
FORD	A4LD (2WD)	1985-1988	7582	515582	Cork 03G582, Nitrile 22G582	18	84GT-7A098-AD, E5TZ- 7A098-B, E6TZ-7A098-B	
FORD	A4LD (2WD)	1989-1996	7586	515586	Cork: 03G582, Nitrile: 22G582	18	E7TZ-7A098-A, E9TZ- 7A098-C, ZZL2-21-500	
FORD	A4LD (4WD)	1985-1996	7584	515584	Cork: 03G582, Nitrile: 22G582	18	85GT-7A098-AC, E5TZ- 7A098-A, E6TZ-7A098-A, XL2Z-7A098-BA, ZZL1-21- 500	
FORD	A4LD-E (4WD), 4R55E, 5R55E (4WD)	1995-ON	7580	515580	Cork: 03G582, Nitrile: 22G582	18	1F0121296, F5TZ-7A098-B, XL2Z-7A098-AB, XL2Z- 7A098-BA, XL2Z-7A098-DA, ZZM1-21-296	09G580 Bolt Can Be Used With 5579 & 5580 S To Retro-fit The A4LD Transmission Back To 1985
FORD	A4LD-E, 4R44E (2WD)	1995-ON	7579	515579	Cork: 03G582, Nitrile: 22G582	18	1F0021296, F5TZ-7A098-A, XL2Z-7A098-AA, XL2Z- 7A098-CA, ZZM0-21-296	

Make	Model	Year	Kit	Filter	Gasket	Pan Bolts	OE Numbers	Notes
FORD	AOD, FIOD (2WD)	1980-1994	7419	515419	Cork: 03G419, 63G419, Nitrile: 22G419	14	EOAZ-7A098-A, EOAZ-7A098-C, E1AZ-7A098-A	
FORD	AOD, FIOD (4WD)	1985-1994	7258	515258	Cork: 03G419, 63G419, Nitrile: 22G419	14	E4TP-7F003-AA, E5TZ-7A098-C	Long Pickup Tube
FORD	AODE	1992-ON	No Kit	514215	NA	NA	F2VP-7H187-AA	Force Motor Filter
FORD	AODE (2WD)	1992-1996	7257	515257	Cork: 03G257, Reusable w/ metal torque limiters: 14G257, Nitrile: 22G257	14	F2VY-7A098-A	
FORD	AODE (4WD 92-ON), (2WD 1992-ON 96-ON)		7256	515256	Cork: 03G257, Reusable w/ metal torque limiters: 14G257, Nitrile: 22G257	14	F4TZ-7A098-A, F6AZ-7A098-A	Long Tube
FORD	ATX	1981-1994	No Kit	514205	NA	NA	E9EP-7E242-AA	Governor Filter
FORD	ATX	1981-1994	7260	515260	Cork: 03G260, Nitrile: 22G260	13	E1EP-7B155, E1EP-7B155-BB, E1FZ-7A098-A, E1FZ-7B098-A, E9FZ-7A098-A	
FORD	AX4N	1998-ON	No Kit	514202	NA	NA	F8DP-7G186-AA	Valve Body Filter
FORD	AX4N (95-ON), AX4S SHO (88-95)	1988-ON	7251	515252	Cork: 03G259, Reusable w/ metal torque limiters: 14G259, Nitrile: 22G259	19	F5DZ-7A098-A, F5DZ-7A098-AA, F5DZ-7A098-BA	Orange
FORD	AX4S	1986-1996	7255	515255	Cork: 03G259, 63G259, Reusable w/ metal torque limiters: 14G259, Nitrile: 22G259	17	E6DZ-7A098-A, F4DZ-7A098-A, F4DZ-7A098-B, F4DZ-7A098EA, F5DZ-7A098-B, F5DZ-7A098-BA	Orange
FORD	AX4S SHO	1996-ON	7253, 7250	515253	Cork: 03G259, 63G259, 03G252, Reusable w/ metal torque limiters: 14G252, Nitrile: 22G259	19, 17	F6DZ-7A098-A, F6DZ-YA098-AA	Green
FORD	AXOD	1986-1990	7259	515259	Cork: 03G259, 63G259, Reusable w/ metal torque limiters: 14G259, Nitrile: 22G259	17	E6DZ-7A098-A	
FORD	AXOD	1986-ON	No Kit	514200	NA	NA	E9SP-7G308-AA	Pump, Valve Body Filter
FORD	AXOD SHO	1988-1993	7254	515254	Cork: 03G259, 63G259, Reusable w/ metal torque limiters: 14G259, Nitrile: 22G259	17	F3DZ-7A098-A, F5DZ-7A098A	
FORD	AXOD-E	1991-ON	No Kit	514201	NA	NA	E9DZ-7H162-A	Valve Body Filter
FORD	C3	1974-1989	7301	515301	Cork: 03G301, Nitrile: 22G301	13	D4ZZ-7A098-A, D4ZZ-7A098-B	
FORD	C4	1964-1965	7543	515543	Cork: 03G474, Nitrile: 22G474	11	C4AZ-7A098-C, C5AP-7A098-D	
FORD	C4	1965-1970	7544	515544	Cork: 03G474, Nitrile: 22G474	11	C5AZ-7A098-C	

Make	Model	Year	Kit	Filter	Gasket	Pan Bolts	OE Numbers	Notes
FORD	C4 (Bobcat, Mustang, Pinto, Versailles)	1974-1981	7274	515274	Cork: 03G474, Nitrile: 22G474	11	D4FZ-7A098-A, D4FZ-7A098-B	Deep Pan
FORD	C4 (Bronco)	1973-1977	7590	515590	Cork: 03G474, Nitrile: 22G474	11	D3BZ-7A098-A, D3BZ-7A098-B, D3TZ-7A098-C	
FORD	C4 (Except Mustang, Pinto, Bobcat, Bronco, '70 Falcon, Maverick)	1970-1981	7474	515474	Cork: 03G474, Nitrile: 22G474	11	D0DZ-7A098-A, D0DZ-7A098-B, D0DZ-7A098-C	
FORD	C5 (4WD)(Bronco, Ranger, Light Trucks)	1983-1986	7184	515184	Cork: 03G474, Nitrile: 22G474	11	E3TZ-7A098-A	Deep Pan
FORD	C5 (Except Peb. Trans.)	1982-1986	7174	515174	Cork: 03G474, Nitrile: 22G474	11	E2AP=7B003-AA, E2DZ-7A098-A	
FORD	C6 (All Except Truck, 4WD)	1966-1975	7529	515529	Cork: 03G529, 63G529, Nitrile: 22G529	17	C6AZ-7A098-A, C6AZ-7A098-B, C6VY-7A098-A, C6VY-7A098-B	
FORD	C6 (All Except Truck, 4WD)	1976-1996	7629	515629	Cork: 03G529, 63G529, Nitrile: 22G529	17	D5AZ-7A098-A, D5AZ-7A098-B, D6AZ-7A098-AA, D6AZ-7A098-BB	
FORD	C6 (Truck, 4WD)	1976-1996	7589	515589	Cork: 03G529, 63G529, Nitrile: 22G529	17	D3TZ-7A098-A, D3TZ-7A098-B	
FORD	CFT23, CVT (European Focus, Focus C-Max)	2004-ON	No Kit	515266	NA	NA	0501-214-113	Deep Pan
FORD	CFT23, CVT (European Focus, Focus C-Max)	2004-ON	No Kit	515587	NA	NA	0501-212-996	Shallow Pan
FORD	CFT30, CVT	2005-2007	No Kit	515202	NA	NA	5F9Z-7B155-AA, 5F9Z-7B155-Y	
FORD	CFT30, CVT	2005-ON	7195	515195	Cork: 03G195, Nitrile: 22G195	22	5F9Z-7A098-A, 5F9Z-7A098-B	
FORD	E40D, 4R100	1989-ON	No Kit	514210	NA	NA	F1TP-7H194-AA	4X4 Accumulator Filter
FORD	E40D, 4R100	1989-ON	No Kit	514211	NA	NA	E9TP-7G308-CA	Shift Filter
FORD	E40D, 4R100 (2WD)	1988-2005	7042	515042	Cork: 03G042, Reusable w/ metal torque limiters: 14G042, Nitrile: 22G042	20	E9TZ-7A098-A, F6TZ-7A098-AB, YC3Z-7A098-AA	Shallow Pan
FORD	E40D, 4R100 (4WD)	1988-2005	7044	515044	Cork: 03G042, Reusable w/ metal torque limiters: 14G042, Nitrile: 22G042	20	E9TZ-7A098-B, F6TZ-7A098-BB, YC3Z-7A098-BA	Deep Pan
FORD	FMX	1978-1981	7530	515530	Cork: 03G530, Nitrile: 22G530	14	D8AZ-7A098-A, D8AZ-7A098-B	Iron Case, Felt
FORD	FMX	1968-1977	7531	515531	Cork: 03G530, Nitrile: 22G530	14	14082735, D0AZ-7A098-A	Iron Case, Brass
FORD	FX, FM	1951-1967	7429	515429	22G530	14	B9AP-7A098-A	Small, Iron Case
FORD	HF35 / EVT	2013-2015	No Kit	515270	NA	NA	DG9Z-7A098-A	
FORD	MX (Except Lincoln)	1960-1967	7431	515431	Nitrile: 22G431	15	B9MP-7A098-B	Medium, Iron Case
FORD (European Models)	CTX	1987-1989	No Kit, Disassembly	515527	NA	NA	87CT-7B155-AA, 87CT-7B155-AB	Filter - CVT (2.5" Tube)
FORD (European Models)	CVT, NCVT, CTX	1989-2001	No Kit	515194	NA	13	6184137, 87CT-7B155-AB	.75" Tube
FORD / GM	6F50, 6F55, 6T70, 6T75	2007-ON	No Kit, Disassembly	515192	NA	NA	24223670, 24240104, 7T4Z-7A098-B	
FORD / MAZDA	4EAT-G, G4AEL, G4AHL, N4A	1986-1987	7847	515847	Cork: 03G847, Nitrile: 22G847	17	FU01-21-500C, FU01-21-500E, FU01-21-500F	.625" Thick

Make	Model	Year	Kit	Filter	Gasket	Pan Bolts	OE Numbers	Notes
FORD / MAZDA	4EAT-G, G4AEL, G4AHL, N4A	1987-1992	7848	515848	Cork: 03G847, 03G848, Nitrile: 22G847, 22G848	17	E92Z-7A098-A, E92Z-7A098-AA, FU31-21-500, FU3A-21-500	1" Thick
FORD / MAZDA	4EAT-G, G4AEL, G4AHL, N4A	1988-1994	7849	515849	22G847	17	FOJY-7A098-A, FU50-21-500A	1.25" Thick
FORD / MAZDA	4F27E, J39A, FN4A-EL	1999-ON	7873	515873	Cork: 03G873, 63G873, Nitrile: 22G873	20	FN01-21-500, XS4Z-7A098-AB, XS4Z-7A098-AC	
FORD / MAZDA	4F27E, J39A, FN4A-EL (99-ON), FNR5, FS5A-EL (05-ON)	1999-ON	7262	515262	Cork: 03G873, 63G873, Nitrile: 22G873	20	6E5Z-7B155-A, 8E5Z-7B155-A, FNC1-21-500	Deep Pan, Sump Filter
FORD / MAZDA	CD4E, LA4AEL	1994-ON	7261	515261	Cork: 03G261, Nitrile: 22G261	14	F3RP-7A098-A, F3RZ-7A098-A, F3RZ-7A098-AA, FW50-21-500	CD4E
FORD / MAZDA	EAT, 4EAT-F, F4E, F4E-III, F4AEL	1990-ON	7943	515943	Cork: 03G843, Nitrile: 22G843	19	FW01-21-500, KFW01-21-500	4EAT-F, F4A-EL
FORD / MAZDA	EAT, 4EAT-F, F4E, F4E-III, F4AEL	1990-ON	7944	515944	Cork: 03G843, Nitrile: 22G843	19	FU61-21-500B	F4EL, 4EATF
FORD / MAZDA	EAT, 4EAT-F, F4E, F4E-III, F4AEL (Escort, Tracer, 323, Protege, Kia Sephia)	1991-ON	7843	515843	Cork: 03G843, Nitrile: 22G843	19	F1CZ-7A098-A, F1CZ-7A098-AA, FU61-21-500B, KFU6-12-1500, MFU6121500B	
FORD / MAZDA	G4AEL	1993-ON	7871	515871	Cork: 03G847, Nitrile: 22G847	17	F32Z-7A098-A, F32Z-7A098-AA, FU9A-21-500	
FORD GETRAG	MPS6	2009-ON	No Kit	515204	NA	NA	7M5R-6C631-AD	
FORD GETRAG	MPS6	2008-ON	No Kit, Disassembly	515588	NA	NA	7M5R-7G186-AB	
FORD GETRAG	SPS6	2009-ON	No Kit	515350	NA	NA	2-1016-010, 7U3R-7G186-AB	
GM	2ML70 2-MODE HYBRID	2007-2013	No Kit	515702	NA	13	1916-8277	
GM	3L30, TH180, TH180C (3 Speed)	1969-ON	7817	515817	Cork: 03G817, Nitrile: 22G817	12	14024456, 25010641, 26950-61A00, 5258130, 747451, 96040620, 9921689	
GM	3T40, TH125, TH125C	1980-ON	7128	515128	Cork: 03G128, 63G128, Nitrile: 22G128	16	25010991, 8665904	With Lipseal (Replaces 515127)
GM	4L30E (4 Speed BMW)	1990-ON	7836	515836	Cork: 03G836, Nitrile: 22G836	16	24111-218-899, 96015432	
GM	4L30E (4 Speed ISUZU)	1990-ON	7180	515180	Cork: 03G180, Nitrile: 22G180	16	8-96015062-0, 8-96041011-0	
GM	4L60E	2005-2007	No Kit	515697	NA	NA	5-9005-000	Auxiliary Pump Filter
GM	4L60E	1993-ON	7703	515703	Cork: 03G700, 63G700, Nitrile: 22G700	16	24200796, 24208148, 24208835, 24229186, 24236798, 24236799	Shallow Pan
GM	4L60E	1998-ON	7704	515704	Cork: 03G700, 63G700, Nitrile: 22G700	16	2420-8576, 24208465, 24208576, 24208813, 8-24208576-6, 8-24208813-3	Deep Pan
GM	4L60E	1993-ON	No Kit	514348	NA	NA	8683769	Shift Filter
GM	4L60E	1993-ON	No Kit	514383	NA	NA	8683768	Force Motor Filter (74 Micron)
GM	4L60E	1993-ON	7701	515701	Cork: 03G700, 63G700, Nitrile: 22G700	16	24200796, 25325574, 8-24200796-6, 8681082, 8685774, 8685950, 96040313	
GM	4L60E (Canyon, Colorado, 2005-ON H3, Sierra, Isuzu)	2005-ON	7707	515707	Cork: 03G700, 63G700, Nitrile: 22G700	16	24225323, 8-24225323-0, 8-24225323-3	Shallow Pan Step Filter

Make	Model	Year	Kit	Filter	Gasket	Pan Bolts	OE Numbers	Notes
GM	4L60E (Corvette)	1997-2007	7705	515705	Cork: 03G700, 63G700, Nitrile: 22G700	16	24208149, 24208574, 24208836	
GM	4L80E	1991-ON	No Kit	514385	NA	NA	8685041	Force Motor Filter
GM	4L80E	1991-1996	7480	515480	Cork: 03G480, Reusable w/ metal torque limiters: 14G480, Nitrile: 22G480	17	8675545, 8678757, 8684221, JLM10952	Shallow Pan
GM	4L80E	1991-ON	No Kit	514380	NA	NA	8661709	Shift Filter
GM	4L80E	1991-ON	No Kit	514381	NA	NA	8661834	PWM Filter
GM	4L80E, THMR2	1997-ON	7481	515481	Cork: 03G480, Reusable w/ metal torque limiters: 14G480, Nitrile: 22G480	17	24204277, 24208847, 24210468, 24210956	Deep Pan
GM	4T40E	1995-ON	7129	515129	Cork: 03G129, Reusable w/ metal torque limiters: 14G129, Nitrile: 22G129	12	24203370, 24221762, 8685185	
GM	4T60, TH440	1983-1993	No Kit	514339	NA	NA	24208456, 8644494	Pump, Valve Body Filter (Old 4342)
GM	4T60, TH440	1983-1993	No Kit	514341	NA	NA	8649474	Shift Filter
GM	4T60, TH440	1983-1993	No Kit	514343	NA	NA	8626876, 8627509	Governor Filter
GM	4T60, TH440	1983-1993	7143	515143	Cork: 03G141, Nitrile: 22G141	19	24228949, 24228950, 8658075, 8662943, 8675989, 8689918	(Replaces 515141)
GM	4T60E	1991-ON	No Kit	514347	NA	NA	8651754	Servo Filter
GM	4T60E	1991-ON	No Kit	514346	NA	NA	8651658	Sol., Force M. Torque Filter
GM	4T60E, 4T65E	1991-ON	7142	515142	Cork: 03G142, Reusable w/ metal torque limiters: 14G142, Nitrile: 22G142	20	24206433, 24227477, 8651651, 8651909	
GM	4T80E	1993-ON	No Kit	514375	NA	NA	8680389	Shift Pressure Control
GM	4T80E	1993-ON	7682	515680	Cork: 03G682, Reusable w/ metal torque limiters: 14G682, Nitrile: 22G682	16	24207361, 8680700	Left Scavenger (Bent)
GM	4T80E	1993-ON	7682	515681	Cork: 03G682, Reusable w/ metal torque limiters: 14G682, Nitrile: 22G682	16	8679416	Right Scavenger (Straight)
GM	4T80E	1993-ON	No Kit, Disassembly	515683	NA	16	8681416	Internal (Requires Disassembly)
GM	5L40E, 5L50E	1999-ON	7690	515690	Cork: 03G978, Reusable w/ metal torque limiters: 14G978, Nitrile: 22G978	22	24117-510-011, 96041844	With Short Tabs

Make	Model	Year	Kit	Filter	Gasket	Pan Bolts	OE Numbers	Notes
GM	5L40E, 5L50E	1999-ON	7691	515691	Cork: 03G978, Reusable w/ metal torque limiters: 14G978, Nitrile: 22G978	22	24117-510-012, 24117-533-699, 24117-557-070, 96042545	With Long Tabs, Plastic Shroud
GM	5L40E, 5L50E	1999-ON	7978	515978	Cork: 03G978, Reusable w/ metal torque limiters: 14G978, Nitrile: 22G978	22	2411-1-423-604, 24111-423-604, 24722100, 96042795	With Long Tabs
GM	6L45E	2007-ON	7993	515993	Cork: 03G708, Reusable w/ metal torque limiters: 14G708, Nitrile: 22G708	18	24117-593-565, 24236595	
GM	6L50, 6L80	2006-ON	7698	515698	Reusable w/ metal torque limiters: 14G698	17	24250364, 24251707, 24258268	With 4.75" Neck, Flat Inlet, Tab Spacer Height 1.003"
GM	6L80	2006-ON	7711	515711	Cork: 03G711, Reusable w/ metal torque limiters: 14G711, Nitrile: 22G711	18	24236518, 24236931	With 4.75" Neck, Inlet Length 1.9"
GM	6L80 (Police Patrol Vehicle Only)	2011-ON	7710	515710	Cork: 03G708, Reusable w/ metal torque limiters: 14G708, Nitrile: 22G708	18	24235900, 24236932, 24251054, 24252158	With 4.25" Neck, PPV, Inlet Length 1.778", Tab Spacer Height .592"
GM	6L80, 6L90	2006-ON	7709	515709	Cork: 03G708, Reusable w/ metal torque limiters: 14G708, Nitrile: 22G708	18	24236517, 24236933	With 4.73" Neck, Inlet Length 2.5", Tab Spacer Height 1.267"
GM	6L90 (Camaro V8 6.2L)	2013-ON	7695	515695	Cork: 03G711, Reusable w/ metal torque limiters: 14G711, Nitrile: 22G711	18	24258269	Inlet Length .478", Tab Spacer Height 1"
GM	6T30 / MH9	2012-ON	No Kit, Disassembly	515188	NA	NA	24261229 (KIT)	
GM	6T40, 6T45	2008-2011	No Kit, Disassembly	515699	NA	NA	24230708, 24246194	
GM	6T40/45/50 GEN 3	2014-ON	No Kit, Disassembly	515696	NA	NA	24274649	No seal at this time
GM	8L45, 8L90	2015-ON	7685	515685	Reusable w/ metal torque limiters: 14G685, Nitrile: 22G685	15	24268875, 24274402	
GM	10L80, 10L90	2018-ON	7290	515290	Reusable w/ metal torque limiters: 14G290	16	24273800 (As marked on filter)	Sump Filter
GM	AF50-8, TG-81C	2016-ON	No Kit, Disassembly	515150	NA	NA	24276543	Sump Filter
GM	POWERGLIDE	1962-1973	7541	515541	Cork: 03G542, Nitrile: 22G542	14	347096, 3849968, 6263005	Square Design
GM	POWERGLIDE	1962-1973	7542	515542	Cork: 03G542, Nitrile: 22G542	14	347096, 3849968, 6263005	
GM	ST300	1964-1969	7435	515435	Nitrile: 22G542	14	1243385, 1374649	
GM	TH200	1976-1987	No Kit	514320	NA	NA	8664811	Aux. Box Filter

Make	Model	Year	Kit	Filter	Gasket	Pan Bolts	OE Numbers	Notes
GM	TH200, M-29 (early)	1976-1979	7591	515591	Cork: 03G591, Nitrile: 22G591	11	25010411, 8628299, 8628935	Brass
GM	TH200, TH200C (MV-9)	1979-1987	7437	515437	Cork: 03G591, Nitrile: 22G591	11	8-08632949-9, 8630789, 8632949, 8638960	Deep Pan
GM	TH200-4R, TH325, TH325-4L	1979-1981	7324	515324	Cork: 03G324, Nitrile: 22G324	15	8632095, 8632630, 8632996	
GM	TH200-4R, TH325, TH325-4L	1981-1990	7439	515439	Cork: 03G439, 63G439, Nitrile: 22G439	16	8634223, 8634931, 8639951	With Lipseal
GM	TH325-4L (M57)	1982-1985	7325	515325	Cork: 03G324, Nitrile: 22G324	15	8635710, 8635981, 8645166	
GM	TH350	1969-1986	7415	515415	Cork: 03G615, 63G615, Nitrile: 22G615	13	347302, 6258504, 6261412, 6438816	Brass (Without Gasket)
GM	TH350	1969-1986	7615	515615	Cork: 03G615, 63G615, Nitrile: 22G615	13	8640848	Nylon, Metal
GM	TH350	1979-1982	7616	515616	Cork: 03G615, 63G615, Nitrile: 22G615	13	1246418, 8641443, 8641910	Felt
GM	TH350	1969-1986	No Kit	514350	NA	NA	6273259, 6273269	Governor Screen - obsolete, use 514371
GM	TH350	1969-1986	No Kit	514351	NA	NA	8640074	Pump Pressure Screen
GM	TH400 (Early)	1964-1967	7434	515434	Cork: 03G533, 63G533, Nitrile: 22G533	13	5579822	
GM	TH400 (Late HP)	1967-1990	7532	515532	Cork: 03G532, 63G532, Nitrile: 22G532	21	12337210, 29506392D, 29540976, 6438326, 6884270	Stainless
GM	TH400 (Late)	1967-1990	7533	515533	Cork: 03G533, 63G533, Nitrile: 22G533	13	12337210, 12360651, 24210386, 6259423, 6437741, 6438348, AAU6690	Felt
GM	TH400 (Late)	1967-1990	7732	515732	Cork: 03G533, 63G533, Nitrile: 22G533	21	1878301862, 29503617, 29506392, 94058636	Brass
GM	TH425	1966-1978	7534	515534	Cork: 03G534, 63G534, Nitrile: 22G534	13	6435766, 6438301, 6438336	
GM	TH700-R4	1982-ON	No Kit	514302	NA	NA	NA	
GM	TH700-R4 (Late)	1982-1993	7700	515700	Cork: 03G700, 63G700, Nitrile: 22G700	16	8642933, 8657926, 8667293	
GM	TH700-R4, 4L60	1982-ON	No Kit	514370	NA	NA	24210086, 8642036	Pump / Valve Body
GM	TH700-R4, 4L60	1982-ON	No Kit	514371	NA	NA	8642423	Governor Filter
GM / SATURN	GM CVT VT-20 (Saturn Vue)	2002-2005	No Kit, Disassembly	515548	NA	NA	24226576	
GM / SATURN	TAAT	1991-ON	No Kit	515549	NA	NA	21002346, 21002496	Internal (Disassembly Required)
GM / SATURN	TAAT	1991-ON	No Kit	515550	NA	NA	21002303, 21003298, 21003361	External Spin- on
GM / SATURN	TAAT	1991-ON	No Kit	514390	NA	NA	21002096	Flushing Filter
GM / SATURN	TAAT	1991-ON	No Kit	514391	NA	NA	21002151	

Make	Model	Year	Kit	Filter	Gasket	Pan Bolts	OE Numbers	Notes
HONDA / ACURA	2 SPEED HONDAMATIC	1973-1980	No Kit, Disassembly	515803	NA	NA	25420-639-000	
HONDA / ACURA	3 SPEED HONDAMATIC	1980-1985	No Kit, Disassembly	515805	NA	NA	25420-PA9-000	
HONDA / ACURA	4 SPEED A0YA, APXA, APX4, BOYA, MPOA, MPWA, MPXA, MP1A, MPJA, PX4B	1992-1997	No Kit, Disassembly	515951	NA	NA	25420-PX4-701, 5-86202512-0	
HONDA / ACURA	4 SPEED A24A, A2YA, A4RA, B4RA, B46A, BDRA, M24A, M4RA, S24A, S4RA	1992-1995	No Kit, Disassembly	515959	NA	NA	25420-P24-J00, 25420-P24-J01	
HONDA / ACURA	4 SPEED A24A, A2YA, A4RA, B4RA, B46A, BDRA, M24A, M4RA, S24A, S4RA (99-00), M4TA, MDLA, MDMA, MP7A, S4XA, SDMA, SKWA, SP7A (99-01), BMXA, SLXA (01-05)	1999-2000	No Kit, Disassembly	515991	NA	NA	25420-P4R-013	
HONDA / ACURA	4 SPEED A6VA, AOYA, APXA, APX4, BOYA, MPOA, MPWA, MPXA, MP1A, MPJA, PX4B	1990-1991	No Kit, Disassembly	515950	NA	NA	25420-PX4-023	
HONDA / ACURA	4 SPEED AK, AS, CA (Integra), F4, G4, L5, PL5X	1983-1989	No Kit, Disassembly	515806	NA	NA	25420-PC9-000, 25420-PC9-010, 25420-PN6-700	
HONDA / ACURA	4 SPEED B7TA, B7VA, B7YA, B7XA, B7ZA, M7ZA	1999-2002	No Kit, Disassembly	515953	NA	NA	25420-P7X-003	
HONDA / ACURA	4 SPEED BAXA (97-02), B6VA (98-99), M6HA, MAXA, MDWA	1997-2002	No Kit, Disassembly	515952	NA	NA	25420-P6H-000, 25420-PAX-003	
HONDA / ACURA	4 SPEED CA, L4, M48A, ML4A, P1	1988-1991	No Kit, Disassembly	515855	NA	NA	25420-PL4-000, 25420-PL4-010	
HONDA / ACURA	4 SPEED G4, L5, PL5X, MPSA, S5	1987-1991	No Kit, Disassembly	515856	NA	NA	25420-PL5-000	
HONDA / ACURA	4 SPEED K4, MY8A, PY8A	1990	No Kit, Disassembly	515958	NA	NA	25420-PY8-J10	
HONDA / ACURA	4 SPEED K4, MY8A, PY8A	1988	No Kit, Disassembly	515957	NA	NA	25420-PK4-000	
HONDA / ACURA	4 SPEED M4TA, MDLA, MDMA, MP7A, S4XA, SDMA, SKWA, SP7A (94-99), A24A, A2YA, A4RA, B4RA, B46A, BDRA, M24A, M4RA, S24A, S4RA (96-98)	1994-1999	No Kit, Disassembly	515960	NA	NA	25420-P56-003, 25420-P56-013	Integra 94-99, CR-V 94-98
HONDA / ACURA	4 SPEED M4TA, MDLA, MDMA, MP7A, S4XA, SDMA, SKWA, SP7A (CR-V), A24A, A2YA, A4RA, B4RA, B46A, BDRA, M24A, M4RA, S24A, S4RA (CR-V), BMXA, SLXA (CR-V)	1994-2005	No Kit, Disassembly	515956	NA	NA	25420-P4R-003, 25420-P4R-013	
HONDA / ACURA	4 SPEED M5HA, M5DA, MPYA	1991-2004	7857	515857	Cork: 03G857, Nitrile: 22G857	14	25420-PY4-000	
HONDA / ACURA	4 SPEED MCVA, MRVA (02-04), BZKA (03-05), MZKA (03-06), BC/MCLA, BZHA/JA/NA, GPLA/PA, MKYA/ZA, MRMA, MZHA/JA, MM7A, MNZA, MZKA, M8SA, MCTA	2002-2008	No Kit, Disassembly	515962	NA	NA	25420-PRP-003	
HONDA / ACURA	4 SPEED MPRA, R0	1990-1993	No Kit, Disassembly	515965	NA	NA	25420-PRO-030	

Make	Model	Year	Kit	Filter	Gasket	Pan Bolts	OE Numbers	Notes
HONDA / ACURA	4 SPEED MPWA ACURA Vigor (92-94), M1WA (95-98)	1992-1998	7858	515858	Cork: 03G858, Nitrile: 22G858	16	25420-PW4-010	
HONDA / ACURA	4 SPEED MR9A	1991-2005	No Kit, Disassembly	515961	NA	NA	25420-PR9-020	
HONDA / ACURA	5 SPEED B/M7WA, MGFA (00-03), BGFA (02-03), M/BAYA (03-07), BDGA (04-06), BYBA, BGHA, MGHA (01-04)	2000-2005	No Kit, Disassembly	515966	NA	NA	25420-P7W-003	Internal
HONDA / ACURA	5 SPEED BBSA, BBTA (Crosstour), 6 SPEED Acura MDX, RL, TL, ZDX, PYRA MV2A (Odyssey Touring)	2010-ON	No Kit, Disassembly	515729	NA	NA	25420-RV2-003	35mm Pickup Tube
HONDA / ACURA	5 SPEED BDKA, MDKA (MDX) (03-06), BJFA, MJBA (Ridgeline) (06-08)	2003-2008	No Kit, Disassembly	515967	NA	NA	25420-RDK-013	
HONDA / ACURA	5 SPEED BGHA, BYBA, MGHA	2001-2004	No Kit	515947	NA	NA	25450-P7W-003	Spin-on
HONDA / ACURA	5 SPEED BGRA, BVGA (Element)	2003-2006	No Kit	515946	NA	NA	25450-RAY-003	
HONDA / ACURA	5 SPEED BJFA (Ridgeline) PSFA (Ridgeline), PN3A (4WD) (Pilot), BBTA (Crosstour)	2005-2011	No Kit, Disassembly	515791	NA	NA	25420-RN3-003	Internal Filter
HONDA / ACURA	5 SPEED BRZA, 6 SPEED MT4A, M7PA, PYRA	2006-ON	No Kit	515788	NA	NA	25430-PLR-003	In Line Filter
HONDA / ACURA	5 SPEED BRZA, MZ2A, MPCA, SPCA, MP5A, SMMA, SP5A	2006-ON	No Kit	515948	NA	NA	25420-RPC-003	
HONDA / ACURA	5 SPEED BVGA (Pilot EX)	2005-2006	No Kit	515969	NA	NA	25420-RDP-003	Internal/Sump Filter
HONDA / ACURA	5 SPEED BVGA (Pilot Main)	2002-2005	No Kit, Disassembly	515954	NA	NA	25420-PGH-003	
HONDA / ACURA	5 SPEED BYFA, MJBA, BWEA, BT3A	2005-2012	No Kit, Disassembly	515790	NA	NA	25420-RWE-004, 25420-RWE-014	
HONDA / ACURA	5 SPEED M8SA (Acura TSX), B90A, M91A, B5RA, B5SA	2007-ON	No Kit, Disassembly	515728	NA	NA	25420-RXH-003	
HONDA / ACURA	5 SPEED MJBA (Acura RL)	2005-2008	No Kit, Disassembly	515789	NA	NA	25420-RJB-004	
HONDA / ACURA	5 SPEED PN4A (2WD), B36A, P36A, PV1A (2WD Main), B97A, BDHA, BDGA	2007-2011	No Kit	515898	NA	NA	25420-R36-003	
HONDA / ACURA	5 SPEED SMMA, CVT SWRA (Honda Jazz Overseas)	2004-ON	No Kit, Disassembly	515727	NA	NA	25420-PWR-003	
HONDA / ACURA	6 SPEED MT4A, M7PA, M8EA (Acura MDX, ZDX, RL)	2010-2011	No Kit, Disassembly	515995	NA	NA	25420-RT4-004	27mm Pickup Tube
HONDA / ACURA	B36A, B97A, B98A, BV1A, BDHA, BDGA, BGRA, BK3A, BK4A, BLJA, BLKA, BYFA, M4VA, MHTA, MJBA, MJBA, MM2A, MURA, P36A, P79A, PGRA, PN3A, PN4A, P36A	1996-2016	7955	515955	NA	NA	25450-P4V-013, 25450-PAV-003	
HONDA / ACURA	CVT M4VA	1996-2000	No Kit	515964	NA	14	25420-P4V-003	
HONDA / ACURA	CVT M4VA (Civic HX)	1996-2000	No Kit, Disassembly	515899	NA	NA	25420-PET-003	

Make	Model	Year	Kit	Filter	Gasket	Pan Bolts	OE Numbers	Notes
HONDA / ACURA	CVT MHTA, SZCA	2003-2005	No Kit, Disassembly	515992	NA	NA	25420-PHT-003	Filter - Main (Civic Hybrid)
HONDA / ACURA	CVT SLYA, MLYA	2001-2005	7968	515968	Nitrile: 22G968	14	25420-PLY-003	
HONDA / ACURA	CVT SWRA	2001-ON	No Kit	515726	NA	NA	25450-PWR-003	Cartridge
HYUNDAI	A4BF3 (Accent 2000-2003, Elantra 2000, Tiburon 6/1999-2001)	1999-ON	7932	515932	Cork: 03G930, 63G930, 63G931, Nitrile: 22G930, 22G931	13	46321-22731	
HYUNDAI / KIA	A4CF1, A4CF2	10/02-1/08	7933	515933	NA	NA	46321-23000	
HYUNDAI / KIA	A4CF1, A4CF2, A5CF1, A5CF2	2008-ON	No Kit	515339	NA	19	46321-23001	
HYUNDAI / KIA	A5GF1, A5HF1	2005-ON	7881	515881	Nitrile: 22G881	14	46321-39010	
HYUNDAI / KIA	A6GF1	2009-ON	No Kit, Disassembly	515336	NA	NA	46321-26000	Replaces 515338
HYUNDAI / KIA	A6LF1, A6LF2	2009-ON	No Kit, Disassembly	515337	NA	NA	46321-3B000	
HYUNDAI / KIA	A8TR1 / A8LR1	2011-ON	No Kit	515335	Gasket included With Pan/Filter	14	45280-4E020, 45280-4E000, 45280-4E001	
ISUZU / MAZDA	JR405E, RC4A-EL	2004-2009	No Kit	515797	NA	NA	897-331-0630	
JATCO	JF402E, JF405E	1999-2007	7894	515894	Nitrile: 22G894	13	45611-02700	
JATCO	JF403E (Geo Storm, Isuzu Impulse)	1990-ON	7189	515189	Cork: 03G189, Nitrile: 22G189	21	8-94385937-0, 8-94428489-0, 94385937	
MAZDA	F3A, KF100 (MX-1), ATX	1981-1986	7807	515807	Cork: 03G807, 03G190, Nitrile: 22G190	17/18	941140860, 94140860, FT01-19-815	With Shallow Pan
MAZDA	F3A, KF100 (MX-1), ATX (Ford Aspire)	1994-1997	7191	515191	Cork: 03G190, 03G191, Nitrile: 22G190	17/16	F4BZ-7A098-A, F4BZ-7A098-AA	
MAZDA	F3A, KF100 (MX-1), ATX (Spectrum, Isuzu)	1987-1993	7190	515190	Cork: 03G807, 03G190, Nitrile: 22G190	17/18	94428489	
MAZDA	F3A, KF100 (MX-1), ATX (Tracer, Festiva)	1989-1993	7592	515592	Cork: 03G191	16	E9BZ-7A098-A, E9BZ-7A098-AA	
MAZDA	F3A, KF100 (MX-1), ATX (Tracer, Festiva)	1986-1989	7845	515845	Cork: 03G190, 03G191, Nitrile: 22G190	17/16	E7GZ-7A098-A, FT21-19-815C, FT21-19-815D	
MAZDA	FW6A-EL	2013-ON	7740	515740	Nitrile: 22G740	16	FZ01-21-500	
MAZDA	GM 17R	1985-1986	7818	515818	Cork: 03G807	18	31728-KF101, 8-94413-320-0, 8-94413320-0, 94413317, 94413320	With Deep Pan
MAZDA	LJ4A-EL	1995-ON	7872	515872	Nitrile: 22G872	17	FX01-19-815	
MAZDA	N4AEL, N4AHL	1988-ON	7823	515823	Cork: 03G416, 63G416, Nitrile: 22G416	14	31728-X8600, MD610736	
MAZDA	R4A-EL	1990-1999	7840	515840	22G838, 03G838	18	31728-41X01, 31728-41X03, 8-94483567-7, BV11-19-815	1" Tube
MAZDA	R4A-EL	1993-1996	7874	515874	Cork: 03G838, Nitrile: 22G838	18	BV65-19-815	1.825" Tube
MAZDA	R4A-EL	1990-1999	7945	515945	Cork: 03G838, Nitrile: 22G838	18	BV56-19-815, BV92-19-815	.825" Tube
MAZDA / VOLKSWAGEN / AUDI / JAGUAR / FORD / NISSAN	JF506E, 5F31, 5F31J, 09A, AG5, RE5F01A	2001-ON	7876	515876	Nitrile: 22G876	20	31728-PW003	(Ford Galaxy, VW Sharran, Seat Alhambra)

Make	Model	Year	Kit	Filter	Gasket	Pan Bolts	OE Numbers	Notes
MAZDA / VOLKSWAGEN / AUDI / JAGUAR / FORD / NISSAN	JF506E, 5F31, 5F31J, 09A, AG5, RE5F01A	2001-ON	7877	515877	Nitrile: 22G876	20	09A-325-429, 09A-325-429A	(VW Golf, Ford Mondeo, Mazda)
MAZDA / VOLKSWAGEN / AUDI / JAGUAR / FORD / NISSAN	JF506E, 5F31, 5F31J, 09A, AG5, RE5F01A	2001-ON	7878	515878	Nitrile: 22G876	20	96042795, FP01-21-500	(Rover 75, Jaguar X Type, Land Rover Freelander)
MERCEDES	722.9	2005-2010	7986	515986	Molded Rubber: 04G986	NA	220-277-0395, 220-277-0695, 221-277-0095, 221-277-0195	
MERCEDES	722.9	2011-ON	NA	515748	Molded Rubber: 04G986	NA	222-277-20-00, 221-277-00-00, 221-277-01-00	
MERCEDES	722.0, 722.1, 722.2	1970-1983	7864	515865	Molded Rubber: 04G865	4	115-270-0398, 115-270-0495	Without Tube
MERCEDES	722.0, 722.1, 722.2	1970-1983	7866	515866	04G865	4	123-270-0098	With 1" Long Tube
MERCEDES	722.0, 722.1, 722.2	1970-1983	7867	515867	04G865	4	109-270-0298, 109-277-0195	With .75" Long Tube
MERCEDES	722.3 (W4A040)	1981-1997	7988	515988	04G868	6	460-277-0195	With 1" Long Tube
MERCEDES	722.3 (W4A040), 722.4 (W4A020)	1981-1997	7868	515868	04G868	6	126-277-0295	No Tube
MERCEDES	722.5 (W5A030)	1990-1997	7864	515864	04G868	6	129-277-0095, 129-277-0195	With Sliding Valve
MERCEDES	722.6 (W5A330, W5A580)	1996-2006	7870	515870	04G870	6	140-272-0095, 140-277-0095, 52108325AA, BU01-19-815, JLM20470	
PORSCHE / MERCEDES	722.6 Tiptronic	2001-2009	No Kit	515445	Molded Rubber: 04G870	NA	722-277-0095	
MERCEDES	722.7 (W5A180)	1998-ON	No Kit	515985	NA	NA	168-377-0295, 168-377-0395	
MERCEDES	724.003 (7G DCT)	2012-ON	No Kit	515750	14G750	8	246-377-03-95, 246-377-14-00, 246-377-24-00	
MITSUBISHI	6 SPEED JF613E	2007-ON	No Kit, Disassembly	515349	NA	NA	2824A007	
MITSUBISHI	A4AF-1 (Hyundai)	2000-ON	7932	515932	Cork: 03G930, 63G930, 63G931, Nitrile: 22G930, 22G931	13	46321-22731	
MITSUBISHI	F4A32-1	1991-ON	7863	515863	Cork: 03G863, 63G863, Nitrile: 22G863	14	46321-38000, MD735572	
MITSUBISHI	F4A33-1	1991-ON	7963	515963	Cork: 03G863, 63G863, Nitrile: 22G863	14	46321-38010	
MITSUBISHI	F4A41, F4A42 (Except Sonata)	1997-2008	7901, Disassembly	515901	NA	NA	MD758691	
MITSUBISHI	F4A41, F4A42, F5A42, F4A51, F4A51-2, F4A5A, F5A51	1997-2009	No Kit	515900	NA	NA	46322-39000, MD752072	Spin On
MITSUBISHI	F4A42 (Hyundai), A4CF1, A4CF2 (Kia)	2008-ON	7339	515339	NA	19	46321-23001	
MITSUBISHI	F4A42 (Hyundai), A4CF1, A4CF2 (Kia)	10/2002-1/2008	No Kit, Disassembly	515933	NA	NA	46321-23000	
MITSUBISHI	F4A42 (Sonata), F5A51 (Hyundai)	1997-2008	7881	515881	Nitrile: 22G881	14	46321-39010	
MITSUBISHI	F4A51	1997-4/1999	No Kit, Disassembly	515880	NA	NA	MD758684	

Make	Model	Year	Kit	Filter	Gasket	Pan Bolts	OE Numbers	Notes
MITSUBISHI	F4A51	5/99-2008	No Kit, Disassembly	515903	NA	NA	MR350441	
MITSUBISHI	KM 170 SERIES, A4AF1, F4A32A, F4A-32-A, W4A32A	1982-1994	7861	515861	Cork: 03G860, 63G860, 63G861, Nitrile: 22G860, 22G861	13/12	46321-36011, MD729955	
MITSUBISHI	KM 170 SERIES, A4AF1, F4A32A, F4A-32-A, W4A32A	1987-1998	7862	515862	Cork: 03G860, 63G860, 63G861, Nitrile: 22G860, 22G861	13/12	46321-36001, 46321-36010, 737840, 94483567, MD673110, MD737840	Except KM W4A32-1
MITSUBISHI	KM 170 SERIES, A4AF1, F4A32A, F4A-32-A, W4A32A (Hyundai S Coupe, Accent)	1993-ON	7930, 7931	515930	Cork: 03G930, 63G930, 63G931, Nitrile: 22G930, 22G931	13	46321-22015, 46321-22040, 46321-22050, MD673110	(Hyundai S Coupe, Accent)
MITSUBISHI	KM170 (Early)	1979-1981	7813	515813	Cork: 03G860, 63G860, Nitrile: 22G860	12	MD707786	
MITSUBISHI	KM170 (Late)	1982-1988	7814	515814	Cork: 03G860, 63G860, Nitrile: 22G860	12	45763-21700, MD707787, MD710056	
MITSUBISHI	KM175, KM177	1988-1992	7860	515860	Cork: 03G860, 63G860, Nitrile: 22G860	12	MD729954	
MITSUBISHI	R4A51, V4A51, R5A51, V5A51	2001-2006	7904	515904	Nitrile: 22G902	20	46321-22040, MR528836	.5" Tube
MITSUBISHI	R4A51, V4A51, R5A51, V5A51	1997-2000	7902	515902	Nitrile: 22G902	20	MR357710	No Tube
MITSUBISHI	R5M31 (Viryca)	2000-2002	No Kit, Disassembly	515905	NA	NA	MR336180, MR567673	
MITSUBISHI	R5M31 (Viryca)	1999-ON	No Kit, Disassembly	515906	NA	NA	MB919852	
MITSUBISHI / HYUNDAI	F1C1, CVT	2001-2009	No Kit, Disassembly	515882	NA	NA	MR515064	
NISSAN	E4N71B	1988-1998	7844	515844	Cork: 03G416, 63G416, Nitrile: 22G416	14	BV01-19-815	
NISSAN	L3N71B	1972-1994	7416, 7812	515416	Cork: 03G416, 03G812, 63G416, Nitrile: 22G416	14	0338-19-815, 31728-X0100, 31728-X0F00, D37Z-7A098-A, D37Z-7A098-B	With Internal Servo
NISSAN	L3N71B	1974-1983	7418	515418	Cork: 03G418, Nitrile: 22G418	17	1758-19-815, D7DZ-7A098-A, D7DZ-7A098-B	With External Servo
NISSAN	L3N71B	1986-1989	7846	515846	Cork: 03G416, 63G416, Nitrile: 22G416	14	31728-51X05, 31728-X0900, BT40-19-815A	
NISSAN	L4N71B	1983-1988	7823	515823	Cork: 03G416, 63G416, Nitrile: 22G416	14	31728-X8600, MD610736	
NISSAN	RE0F08A/B, JF009E CVT	2007-ON	No Kit	515508	NA	15	NA	Curved Inlet
NISSAN	RE0F06A CVT	1996-2006	7725	515725	Nitrile: 22G725	20	31728-8E000	
NISSAN	RE0F10A /D, JF016E, JF011E CVT 8 W1CJC	2007-ON	7495	515495	Nitrile: 22G495	20	05191890AA, 5191890AA	Short Square Inlet
NISSAN	RE0F10A /D, JF016E, JF011E CVT 8 W1CJC	2007-ON	No Kit	515497	NA	NA	31726-1XF00, 31726-1XZ0A	Cartridge
NISSAN	RE0F10A /D, JF016E, JF011E CVT 8 W1CJC (4WD)	2007-ON	7946	515496	Nitrile: 22G496	21	31728-1XF03, 31728-1XZ0A	Sump Filter, Long Square Inlet
NISSAN	RE4R03A	1989-2002	7839	515839	Nitrile: 22G839	18	31728-51X02, 31728-51X08	

Make	Model	Year	Kit	Filter	Gasket	Pan Bolts	OE Numbers	Notes
NISSAN	RE5R05A	2004-2013	7343	515343	Nitrile: 22G934	22	31728-7S110, 31728-7S11A	Sump Filter
NISSAN	RE5R05A	2002-ON	7934	515934	Nitrile: 22G934	22	31728-97X00	
NISSAN	RL3F01A (FWD)	1981-1986	7808	515808	Cork: 03G808, 63G808, Nitrile: 22G808	14	31728-01X09	Uniform .25" Inlet
NISSAN	RL4F02A	1985-ON	7842	515842	Nitrile: 22G842	16	31728-21X00, 31728-21X01, 31728-21X02	RL4F02A
NISSAN	RL4F03A (Sentra)	1991-ON	7837	515837	Cork: 03G837, Nitrile: 22G837	21	31728-31X01	
NISSAN	RN3F01A (FWD)	1987-1992	7841	515841	Cork: 03G808, 63G808, Nitrile: 22G808	14	31728-01X10	
NISSAN	RN3F01A, RL3F01A	1978-1982	7939	515939	Cork: 03G808, 63G808, Nitrile: 22G808	14	31728-01X08	Graduated Inlet
NISSAN / FORD	RE4F04A	1999	7936	515936	Cork: 03G937, Nitrile: 22G937	21	31728-80X04	
NISSAN / FORD	RE4F04A	2002-ON	7938	515938	Cork: 03G937, Nitrile: 22G937	21	31728-85X01, 31728-85X0A	
NISSAN / FORD	RE4F04A, RE4F04V	1992-ON	7937	515937	Cork: 03G937, Nitrile: 22G937	21	31728-80L01, 31728-80X03, 31728-80X04, F3XY-7A098-A, F3XY-7A098-AA, F7XY-7A098-AA	
NISSAN / INFINITI	JF011E / RE0F01A CVT	2011-2017	No Kit	515499	NA	NA	31728-3TX0A	Round 1.5865" long inlet
NISSAN / INFINITI	RE0F09A, RE0F09B / JF010E ECVT	2003-ON	7498	515498	Nitrile: 22G498	21	F09-G28-403	Round Inlet
NISSAN / INFINITI	RE0F10E / JF017E CVT 8 (4WD)	2013-ON	No Kit	515787	NA	NA	31728-29X0A	Angled Inlet Length 1.848"
NISSAN / INFINITI	RE7R01A / JR710E, JR711E	2008-ON	7785	515785	Nitrile: 22G785	24	NA	
NISSAN / INFINITI / SUZUKI	RE0F11A / JF015E CVT 7	2010-2014	No Kit	515783	NA	NA	31726-3JX0A	Cartridge
NISSAN / INFINITI / SUZUKI	RE0F11A / JF015E CVT 7	2010-2014	7784	515784	Nitrile: 22G784, Farpak: 05G784	15	31728-3JX0A, 31728-3JX0B	Inlet Length 1.062"
NISSAN / MAZDA	R4AEL (B2600), R4AEL (RX-7) (88-92)	1988-1998	No Kit	515875	NA	NA	BV50-19-815	Inlet Length 1.611", Inlet Height .710"
NISSAN / MAZDA	RE4R01A (2WD) (Pathfinder, Pickup), RG4R01A, JR403E (88-98)	1987-2004	7838	515838	Cork: 03G838, Nitrile: 22G838	18	31728-41X00, 31728-41X02, 31728-41X04	
NISSAN / MAZDA	RE4R01A (4WD) (Pathfinder)	1987-2004	7840	515840	Cork: 03G838, Nitrile: 22G838	18	31728-41X01, 31728-41X03, 8-94483567-7, BV11-19-815	Pickup, 1" Tube
NISSAN / MAZDA	RE4R01A (R4AEL), RL4R01A, RE5R01A	1988-1995	7945	515945	Cork: 03G838, Nitrile: 22G838	18	BV56-19-815, BV92-19-815	
NISSAN / MAZDA	RE5R01A	1991-2000	No Kit	515884	NA	18	31728-60X01	Inlet Length 1.574"
NISSAN / MAZDA	RE5R01A (BMW)	1991-2000	No Kit	515935	NA	18	24341-423-109, 31728-60X01	Inlet Length 1.696", Inlet Height .689"
NISSAN / MAZDA	RL4R01A (2WD) (4 Cyl. Pickup)	1989-2004	7940	515940	Cork: 03G838, Nitrile: 22G838	18	31728-48X00, 31728-48X01	Inlet Length .125"
RENAULT	AD4 (Scenic, CLIO)	1990-ON	No Kit	515720	NA	4	7701-467-106	
RENAULT	AD8 (Safrane)	1993-ON	No Kit	515722	NA	7	7701-467-878	
RENAULT	MB1, MJ1, MJ3, 4139 (Alliance, Encore)	1986-ON	No Kit	515715	NA	NA	7700-712-751, T0717533, T0727392	

Make	Model	Year	Kit	Filter	Gasket	Pan Bolts	OE Numbers	Notes
RENAULT	MB1, MJ1, MJ3, 4139 (Alliance, Encore)	1983-1985	No Kit	515717	NA	NA	7700-712-571, 7700-723-787, 7700-723-943, 7700-734-655, T0712571, T0734655	
RENAULT	MB1, MJ1, MJ3, 4139 (Eagle Medallion)	1988-1989	No Kit	515718	NA	NA	7700-739-883, T0739883	
RENAULT	MB1, MJ1, MJ3, 4139 (Eagle Medallion, Premier AR4)	1988-1989	No Kit	515719	NA	NA	7700-746-294, J0746294, J1467103, T0741006	
RENAULT / PEUGEOT	DPO, AL4	1998-ON	No Kit, Disassembly	515721	NA	NA	7701-107-578	
SUBARU	5 Speed, 5EAT	2005-ON	7355	515355	Nitrile: 22G355	21	NA	
SUBARU	ECVT (Justy)	1989-1994	7851	515851	Nitrile: 22G851	13	31728-KA000, 31728-KA030, 31728-KA031	
SUBARU	M41, M41A	1975-ON	7416	515416	Cork: 03G416, 63G416, Nitrile: 22G416	14	0338-19-815, 31728-X0100, 31728-X0F00, D37Z-7A098-A, D37Z-7A098-B	
SUBARU	R4AX-EL, 4EAT, EC-8 (Except Legacy, SVX, Loyale)	1987-1991	7850	515850	Cork: 03G850, Nitrile: 22G850	20	31728-AA000	Inlet Height .125"
SUBARU	R4AX-EL, 4EAT, EC-8 (Legacy, Forester)	1999-ON	7854	515854	Nitrile: 22G854	20	31728-AA050	
SUBARU	R4AX-EL, 4EAT, EC-8 (Legacy, Forester)	1999-ON	No Kit	515859	NA	NA	38325-AA030, 38325-AA031, 38325-AA032, 38325-KA000	Spin-on
SUBARU	R4AX-EL, 4EAT, EC-8 (Legacy, Forester, Impreza, Outback)	2004-ON	No Kit	515883	NA	20	31728-AA130	
SUBARU	R4AX-EL, 4EAT, EC-8 (Legacy, SVX, Loyale)	1990-1992	7853	515853	Cork: 03G850, Nitrile: 22G850	20	31728-AA010, 31728-AA011	Inlet Height .603"
SUBARU	SB308 SB308 (Suzuki Corsa)	1988-ON	No Kit, Disassembly	515852	NA	NA	26570-78231	
SUZUKI	WAGON R SR410-2, SR412-2	1999-2003	No Kit	515892	NA	16	26570-55A10	
SUZUKI	WAGON R SR410-2, SR412-2	1999-2003	No Kit	515893	NA	16	26570-75F10	
SUZUKI / NISSAN	AW03-72LS, A44DE	2009-2013	No Kit	515380	NA	14	26570-65D10	
TOYOTA	A130, A130L, A131A, A131L, A132L (Geo Prizm, Toyota Tercel, Corolla), A140E, A140L, A141E, A142E, A142L (Camry, Celica, MR2)	1983-ON	7920	515920	Cork: 03G820, Nitrile: 22G820	15	35330-20010, 35330-20012, 35330-20H00, 94850449	
TOYOTA	A130, A140E, A140L, A141E, A142E, A142L	1983-ON	7820	515820	Cork: 03G820, Nitrile: 22G820	15	35303-32010, 35330-32010, 94840966	A142L (Chevy Nova, Toyota Camry)
TOYOTA	A140E, A140L, A141E, A142E, A142L (Camry SXV 10, Celica)	1991-ON	7921	515921	Cork: 03G820, Nitrile: 22G820	15	35330-32022, 94850882	
TOYOTA	A240E, A240L, A241E, A241L, A243E, A243L, A244E, A245E (Celica, Corolla, Geo Prizm), A246E, A247E	1985-ON	7925	515925	Cork: 03G925, Nitrile: 22G925	18	35330-12030, 94853372	
TOYOTA	A240E, A240L, A241E, A241L, A243E, A243L, A244E, A245E (Corolla)	1985-1999	7825	515825	Cork: 03G825, Nitrile: 22G825	18	35330-12010, 35330-12011, 35330-12020, 94844936	
TOYOTA	A240E, A240L, A241E, A241L, A243E, A243L, A244E, A245E (Paseo 4.1, 1.5L)	1991-ON	7926	515926	Cork: 03G825, Nitrile: 22G825	18	94840882, 94849051, 94850882	

Make	Model	Year	Kit	Filter	Gasket	Pan Bolts	OE Numbers	Notes
TOYOTA	A246E	2003-ON	7923	515923	Nitrile: 22G923	18	35330-12040, 88972067	
TOYOTA	A30 (3 Speed) Front	1968-1978	7804	515801	Nitrile: 22G801	16	35303-30013	
TOYOTA	A30 (3 Speed) Rear	1968-1978	7804	515802	Nitrile: 22G801	16	35306-30011	
TOYOTA	A340E (2WD)	1985-ON	7829	515829	Cork: 03G310, Nitrile: 22G310	19	35330-30010, 35330-30011, 35330-33001	
TOYOTA	A340E (Jeep Eagle)	1987-ON	7310	515310	Cork: 03G310, Nitrile: 22G310	19	5083122AA, 83504032, 83504032AB, MR195988	
TOYOTA	A340E (R4AW3), A340F, A340H (V4AW3), A341E, A343E (Land Cruiser, Lexus), A343F (Land Cruiser, Lexus)	1995-ON	7915	515915	Cork: 03G310, Nitrile: 22G310	19	35330-60030, 8-97207143-0	
TOYOTA	A340E (R4AW3), A340F, A340H (V4AW3), A341E, A343E (Lexus GS300)	1996	7913	515913	Cork: 03G310, Nitrile: 22G310	19	35330-30040	
TOYOTA	A340E (R4AW3), A340F, A340H (V4AW3), A341E, A343E (Lexus GS300)	1993-1995	7919	515919	Cork: 03G310, Nitrile: 22G310	19	35330-30020	
TOYOTA	A340E (R4AW3), A340F, A340H (V4AW3), A341E, A343E (Lexus LS / SC400 V8)	1990-ON	7828	515828	Cork: 03G310, Nitrile: 22G310	19	35330-50010, 354192008, 3549200-8, 35492008	
TOYOTA	A340F (T100 P / U 8/97-ON, Tacoma P / U 9/96-99, 4Runner), A343F (Land Cruiser, Lexus)	1995-ON	7928	515928	Cork: 03G310, Nitrile: 22G310	19	35330-60020	Pickup, .75" Tube
TOYOTA	A340F (Toyota T100 P / U 94-8/97, Tacoma 95-9/96)	1994-1997	7929	515929	Cork: 03G310, Nitrile: 22G310	19	35330-22010	
TOYOTA	A340H (4WD)	1985-ON	7827	515827	Cork: 03G310, Nitrile: 22G310	19	35303-35010, 8-94479921-0, 8-94479921-1, MR166573	
TOYOTA	A343F (Land Cruiser, 4Runner)	1995-ON	7918	515918	Cork: 03G310, Nitrile: 22G310	19	35330-35020	
TOYOTA	A440F	1988-ON	7832	515832	Cork: 03G830, Nitrile: 22G830	20	35330-60011	.625" Thick
TOYOTA	A440F	1985-1992	7830	515830	Cork: 03G830, Nitrile: 22G830	20	35303-60010, 35303-60011	2" Thick
TOYOTA	A442F	1993-1995	7927	515927	Cork: 03G830, Nitrile: 22G830	20	35330-60010	
TOYOTA	A442F (Land Cruiser 100 Series - Non USA Only)	2003-ON	7793	515793	Cork: 03G830, Nitrile: 22G830	20	35330-60040	
TOYOTA	A540E, A540H, A541E	1993-ON	7924	515924	Cork: 03G831, Nitrile: 22G831	17	35330-33010, 35330-33030	
TOYOTA	A540E, A540H, A541E (RAV4, Sienna)	1993-ON	7831	515831	Cork: 03G831, Nitrile: 22G831	17	35330-32030, 35330-32031	
TOYOTA	A55 (2WD)	1979-1986	7821	515821	Cork: 03G821, Nitrile: 22G821	17	35303-16010, 35303-16020, 35303-16H00	.25" Thick
TOYOTA	A55 (4WD)	1982-1986	7826	515826	Cork: 03G821, Nitrile: 22G821	17	35303-16030	.625" Thick
TOYOTA	A650E (IS200)	2000-ON	7907	515907	Cork: 03G800, Nitrile: 22G800	14	35330-22032	
TOYOTA	A650E (Lexus GS400/GS430, IS300, IS400/IS430, SC400/SC430)	1997-ON	7910	515910	Cork: 03G310, Nitrile: 22G310	19	35330-30070	
TOYOTA	A750E, A750F	2003-ON	7909	515909	Nitrile: 22G909	20	35330-60050	
TOYOTA	A960E	2006-ON	No Kit	515798	NA	NA	35330-30090	

Make	Model	Year	Kit	Filter	Gasket	Pan Bolts	OE Numbers	Notes
TOYOTA	MX17 (A210) (Chevy Sprint)	1985-ON	7819	515819	Cork: 03G819, Nitrile: 22G819	15	26570-82300, 35303-87703-000, 96053975	
TOYOTA	MX17 (A210) (Daihatsu)	1988-1991	7891	515891	Nitrile: 22G891	16	35303-87200	Pan
TOYOTA	U140E	1999-ON	7916	515916	Cork: 03G916, Nitrile: 22G916	18	35330-06010, 35330-0W010, 35330-21020	
TOYOTA	U151	2004-ON	7911	515911	Cork: 03G916, Nitrile: 22G916	18	35330-08010	
TOYOTA	U340E (Old Design)	1999-ON	7912	515912	Cork: 03G912	14	35330-20020	
TOYOTA	U341E (Lexus)	1999-ON	7917	515917	Nitrile: 22G917	19	35330-0W020, 35330-0W021, 35330-20020, 88971813	
TOYOTA / DAIHATSU A4LB1 (Serion)		1994-ON	No Kit	515897	NA	NA	35303-97201	
TOYOTA / DAIHATSU A4LB1, U540E (Terios)		1994-2009	No Kit	515896	NA	NA	35303-97501	
TOYOTA / LEXUS	A760, AB60E, AB60F	11/2007-ON	7794	515794	Nitrile: 22G909	20	35330-60060	Long Inlet
TOYOTA / LEXUS	A761E (Toyota, Lexus)	2003-ON	7799	515799	Nitrile: 22G909	20	35330-50020	Felt Media
TOYOTA / LEXUS	U660E, U660F	2007-ON	7795	515795	Nitrile: 22G795	18	35330-33050	
TOYOTA / LEXUS	U760E, TM-60LS	2009-ON	7796	515796	Cork: 03G796, Reusable w/ metal torque limiters: 14G796, Nitrile: 22G796	19	35330-73010	
TOYOTA / MITSUBISHI	A40, A41, AW55, BW55	1974-1981	7800	515800	Cork: 03G800, Nitrile: 22G800	14	35303-22020, 35303-22021, 35303-22022, 53446-80011, 5344680011	
TOYOTA / MITSUBISHI	A40D, A41D	1978-ON	7815	515815	Cork: 03G800, Nitrile: 22G800	14	35303-30030, 35303-30031	
TOYOTA / MITSUBISHI	A42D, A43D, AW70, AW71	1981-ON	7811	515811	Cork: 03G800, Nitrile: 22G800	14	1239829-3, 35303-30050, 8-94244562-0, 8-94244562-2, MD609041	
TOYOTA / MITSUBISHI	A42DL, A43DL, A44DL, A45DL	1982-ON	7810	515810	Cork: 03G800, Nitrile: 22G800	14	1340021-3, 35303-14010, 8-94405362-0, 8-94405362-2, MD609189	
TOYOTA / MITSUBISHI	A43D	2002-2004	7908	515908	Cork: 03G800, Nitrile: 22G800	14	35303-35020	
TOYOTA / MITSUBISHI	A43DE (4 Speed), A46DE, A46DF	1990-ON	7822	515822	Cork: 03G800, Nitrile: 22G800	14	0K0-151-9815, 26582-57B00, 35303-30060, 91172478, BV8B-19-815, OK01519815	
VOLKSWAGEN / AUDI	010, 087, 089, 090	1975-1977	7410	515410	Molded Rubber: 04G420	NA	010-325-421	Rectangular
VOLKSWAGEN / AUDI	010, 087, 089, 090	1977-1993	7420	515420	Molded Rubber: 04G420	NA	010-325-421A	Round
VOLKSWAGEN / AUDI	01J (CVT), OAW (CVT)	2002-ON	No Kit, Disassembly	515723	NA	NA	01J-301-519L	
VOLKSWAGEN / AUDI	09E	1969-1976	7417	515417	Cork: 03G417, Nitrile: 22G417	13	003-325-421	
VOLKSWAGEN / AUDI	09K (European Version)	2004-ON	No Kit	515724	NA	7	09K-325-429	
VOLKSWAGEN / AUDI	09M	2003-ON	No Kit	515432	NA	9	09M-325-429	
VOLKSWAGEN / AUDI	0B5 (DL501) DCT 7 SPEED DSG	2008-ON	7996	515996	Nitrile: 22G996	15	0B5-325-429E	
VOLKSWAGEN / AUDI	AG4	1990-1995	7425	515425	Molder Rubber: 04G425	NA	095-325-429C, 095-325-429D	
VOLKSWAGEN / AUDI	AG4	1996-ON	7427	515427	Molder Rubber: 04G425	4	01M-325-429	
VOLKSWAGEN / AUDI	AL450 (VW Amarok)	2012-2014	No Kit	515371	NA	13	0501-218-004	

Make	Model	Year	Kit	Filter	Gasket	Pan Bolts	OE Numbers	Notes
VOLKSWAGEN / AUDI	DSG / 02E DSG (6 Speed)	2003-ON	No Kit	515424	NA	NA	02E-305-051B, 02E-305-051C	
VOLKSWAGEN / AUDI	JF404E	1999-ON	No Kit, Disassembly	515430	NA	NA	001-325-429	
VOLKSWAGEN / AUDI	JF404E	1999-ON	7879	515879	Nitrile: 22G879	20	001-325-429A	
VOLKSWAGEN / AUDI	TF60SN, 09G	2004-ON	7422	515422	Molded Rubber: 04G423	8	09G-325-429-A	With wide raised intake
VOLKSWAGEN / AUDI	TF60SN, 09G (VW Golf L5 2.5L)	2007-ON	7423	515423	Molded Rubber: 04G423	8	09G-325-429	With narrow flush intake
VOLKSWAGEN / AUDI	TR60SN, 09D	2002-ON	7428	515428	Molded Rubber: 04G428	16	09D-325-429, 09D-325-435	
VOLKSWAGEN / AUDI	TR80SD	2010-ON	7433	515433	Molded Rubber: 04G433	11	0C8-325-435	Inlet Height 1.294"
ZF	3HP22 (BMW)	1976-1984	7816	515816	Molded Rubber: 04G816	NA	1024-223-002, 24341-209-747	
ZF	4HP18 (Transverse)	1986-ON	7834	515834	Molded Rubber: 04G833	NA	1501-311-497, 7575525, 7599525	
ZF	4HP18, 4HP14	1986-ON	7833	515833	Molded Rubber: 04G833	NA	1036-226-013, 4728878, 83504685	In-line
ZF	4HP18, 4HP18FLE (Audi Only)	1991-ON	7426	515426	Molded Rubber: 04G833	NA	01F-325-433, 01M-325-429, 0501-004-608, 0501-004-609	
ZF	4HP20	1998-ON	7975	515975	Molded Rubber: 04G975	NA	0501-315-183, 1019-222-019	Long Tube
ZF	4HP20 (Peugeot), 4HP16 (04-ON)	1995-1999	7977	515977	Molded Rubber: 04G975	NA	0501-315-184, 26440-86200, 93742042	Short Tube
ZF	4HP22	1993-1995	7982	515982	Molded Rubber: 04G824	NA	943-307-011-01, 943-307-011-02	
ZF	4HP22 (BMW), 4HP-24	1987-ON	7835	515835	Molded Rubber: 04G424	NA	1043-226-034, 24311-218-204, 24311-218-571, JLM2128	1" Pickup Tube
ZF	4HP22 (Except Rover)	1982-ON	7824	515824	Molded Rubber: 04G824	NA	1043-226-036, 24311-218-550, 24341-215-544, 24341-215-550, E4LY-7A098-A, JLM2122, JLM664	No Pickup Tube
ZF	4HP22 (Rover), 4HP-24 (Rover) (87-ON)	1985-1994	7979	515979	Molded Rubber: 04G824	NA	1043-226-037, RTC4653	.625" Pickup Tube
ZF	4HP24A	1989-1994	7974	515974	NA	NA	1043-226-035	2.5" Pickup Tube
ZF	5HP18	1991-1995	7984	515984	Molded Rubber: 04G984	NA	0501-005-185, 24341-219-631, 24341-422-513	
ZF	5HP19, 5HP19FL, 5HP19FLA	1997-2004	7971	515971	Nitrile: 22G971 (22 holes), 22G981 (27 holes)	27, 22	0501-210-388, 24341-423-376	
ZF	5HP24, 5HP24A (2WD)	1995-2006	7983	515983	Nitrile: 22G983	22	01L-325-429, 0501-004-925, 24341-422-673, JLM20216	Slotted Intake
ZF	5HP24, 5HP24A (4WD)	1995-2006	7973	515973	Nitrile: 22G973	26	01L-325-429B, 0501-006-460	.75" Tube
ZF	5HP24, 5HP24A (4WD)	1995-2006	7976	515976	Nitrile: 22G983	22	01L-325-429-A, 01L-325-429A	1" Tube
ZF	5HP30	1992-2003	7980	515980	Nitrile: 22G980	23	0501-005-184, 24341-421-200, 24341-422-229, 24341-422-419	

Make	Model	Year	Kit	Filter	Gasket	Pan Bolts	OE Numbers	Notes
ZF	6HP19, 6HP19A, 6HP19X	2001-2011	No Kit	515442	NA	13	0501-212-401, 09L-325-429	Overall Height 5.56"; Outlet Tube Height 4.80" / 122mm
ZF	6HP19, 6HP19A, 6HP19X	2004-ON	No Kit	515987B	Includes pan gasket, drain plug and magnets	24	24117-536-387, 24117-571-217	(Revision of 515987 With Replaceable Filter Includes Pan Gasket, Drain Plug And Magnets)
ZF	6HP26, 6HP26A, 6HP26X	2002-2009	No Kit	515970B	Includes pan gasket, drain plug and magnets	21	21117-522-923, 24117-522-923, 24117-571-227, C2C-6715	(Revision of 515970 With Replaceable Filter Includes Pan Gasket, Drain Plug And Magnets)
ZF	6HP26, 6HP26A, 6HP26X (2WD)	2007-2009	7263	515263	Cork: 03G263, Reusable w/ metal torque limiters: 14G263, Nitrile: 22G263	21	NA	1.5" Pickup Tube
ZF	6HP26, 6HP26A, 6HP26X (2WD)	2002-2006	7264	515264	Cork: 03G263, Reusable w/ metal torque limiters: 14G263, Nitrile: 22G263	21	6L2Z-7A098-AA	Flat Bottom, 3.003" Neck
ZF	6HP26, 6HP26A, 6HP26X (4WD)	2004-2009	7421	515421	Nitrile: 22G421	24	0501-212-974, 09E-325-429	3.534" Neck
ZF	8HP45	2011-ON	No Kit	515768	NA	13	0501-218-048, 68142478AB	Shallow Pan With Replaceable Filter Includes Pan Gasket, Drain Plug And Magnets
ZF	GACVT16Z (Mini Cooper 1.6L, Mini One R50, Austin CVT)	2002-2009	7994	515994	Nitrile: 22G994	NA	24117-518-741	
ZF	ZF5HP19FLA (Audi)	1995-2004	7981	515981	Nitrile: 22G981	27	01V-325-421, 01V-325-429, 0501-209-251, 722-277-009-05, 986-307-001-01	
ZF CHRYSLER	8HP45X, 8HP55A, 8HP55AH, 8HP70XH, 8HP90 (VW Amarok)	2012-2014	No Kit	515371	NA	13	0501-218-004	OE Transmission Filter
ZF CHRYSLER	8HP55 / OBK, 8HP70, 8HP50Z (4WD/AWD)	2010-ON	7370	515370	Reusable w/ metal torque limiters: 14G370	12	PART OF OBK398009	
ZF CHRYSLER	8HP70	2010-ON	No Kit	515769	Includes pan gasket, drain plug and magnets	13	52854834AA	(Deep Pan With Replaceable Filter Includes Pan Gasket, Drain Plug And Magnets)
ZF CHRYSLER	8HP70/8HP50Z	2011-ON	No Kit	515770	Includes pan gasket, drain plug and magnets	13	0501-220-614	OE Transmission Filter (Shallow Pan/Filter Combo, Gasket And Drain Plug Included)

Make	Model	Year	Kit	Filter	Gasket	Pan Bolts	OE Numbers	Notes
ZF CHRYSLER	9HP48, 948TE	2013-ON	No Kit, Disassembly	515625	NA	NA	0501-217-695	
ZF GETRAG	GS7D36SG	2007-ON	No Kit	515225	NA	NA	28-10-7-842-828	
Transmission Cooler	Line size 1/2" Magnetic In-Line Filter with Bypass	NA	7553	515553	NA	NA	2W4Z-7B155-BA, 2W4Z-7B155-E	
Transmission Cooler	Line size 3/8" Magnetic In-Line Filter with Bypass	NA	7554	515554	NA	NA	XC3Z-7B155-BA	
Transmission Cooler	Line size 5/16" Magnetic In-Line Filter with Bypass	NA	7555	515555	NA	NA	3610 MAG	
Transmission Pan	Chrysler 42RLE	2006-2013	No Kit	RP42RLE	NA	13	52852912AC	Transmission Pan - Coated Steel, No Drain Plug
Transmission Pan	Ford C6 (2WD)	1966-UP	No Kit	RPC6	NA	17	F5TZ-7A194-D	Transmission Pan - Uncoated Steel, With Drain Plug (2WD)
Transmission Pan	Ford C6 (2WD)	1966-UP	No Kit	RPC6B	NA	17	F5TZ-7A194-D	Transmission Pan - Coated Steel, No Drain Plug (2WD)
Transmission Pan	Ford E40D, 4R100	1996-2005	No Kit	RPE40D	NA	20	F81Z-7A194-BA	Transmission Pan - Coated Steel, Deep Pan With Drain Plug
Transmission Pan	GM 4T45E, 4T40	1995-2011	No Kit	RP4T45E	NA	14	8685184	Transmission Pan - Coated Steel, No Drain Plug
Transmission Pan	VW 09G / TF60SN, 09K, 09M	2003-ON	No Kit	RP09G	NA	8	09G-321-361A	Transmission Pan - Coated Steel, With Drain Plug
Transmission Pan Magnet	1.33" X 1.33" (33.75mm), NA Metallic, Square		No Kit	RM900075	NA	NA	NA	
Drain Pan Funnel	23" X 23", Plastic	NA	No Kit	624999	NA	NA	NA	